

TIMBER - A FASHIONABLE CONSTRUCTION MATERIAL

Eng. Nandana Abeysuriya

BSc.Eng(Hons),MEng. ,CEng., FIE(SL),,IntPE(SL),,MConsE(SL),,MSSE(SL)

-Managing Director - NCD Consultants(pvt) Ltd

Abstract

Timber is the oldest construction material. Timber taken from well managed forests ,is the most sustainable construction material. It gives the minimum or no effects to environment when disposed as construction waste. The most attractive feature in structural timber , is the high strength to weight ratio of timber which can be used to transfer tension , compression and shear . Architects love to work with timber , as it has unique characteristics such as natural grain patterns, colours and colour variations, fine finishes and the various features of the species.

When compared to other construction materials such as reinforced concrete or structural steel, solid timber members use for building industry such as columns, beams , floor boards etc has a limit for section sizes and length. The cost of large sections are more expensive than that of small sections. This limitation can be overcome with composite or built up timber sections.

Timber has been used by Sri Lankan builders extensively during the ancient days. The main reasons are the availability in large quantities in our forests , convenience in shaping and connecting with nails or timber wedges and the skill in the trade given by forefathers. Their inventions were not limited to kitchen utensils, agricultural tools, transport facilities or recreational facilities. Ancient carpenters added beauty to their building construction by introducing fine details to timber members and connections.

The new generation has realised the value of this natural material and the sustainability compared to other major construction materials. Therefore it is the duty of Engineers to use advance technology and find most efficient use in order to make them more cost effective. Some of the applications in this context are the use of built up members to replace solid sawn timber or proper connections to form large members out of small sections. This paper shall also discuss about Some of the efficient timber structural forms used by the author .

1.0 INTRODUCTION

Timber is the only building material on earth which is naturally renewable , recyclable and leaves a lighter foot print than any other. In it's production, the embodied energy in wood is a fraction of energy required to produce almost any other building material.

Timber has been available as a construction material for most societies since the human race first started to build crude shelters at the dawn of civilisation.

Timber has been used in the construction of buildings, bridges, machinery war engines, civil Engineering works, boats etc since mankind first leant to fashion tools. So it is important to discuss about the history of the use of this fashionable material and how best use in the future.

2.0 HISTORY OF TIMBER CONSTRUCTION

Primeval man – Homo sapiens neanderthalensis (120,000 – 40,000 BC) did not live in caves , but also in primitive shelters. The shelters constructed by primeval man were made of a framework of suitable tree branches interlaced with deciduous tree branches or covered with grass as shown in figure 01 . The first timber framed houses were constructed by the first farmers between 4500 -3000 BC. These houses transformed to longhouses later. Figure 02 , 03 and 04 shows some typical old houses.

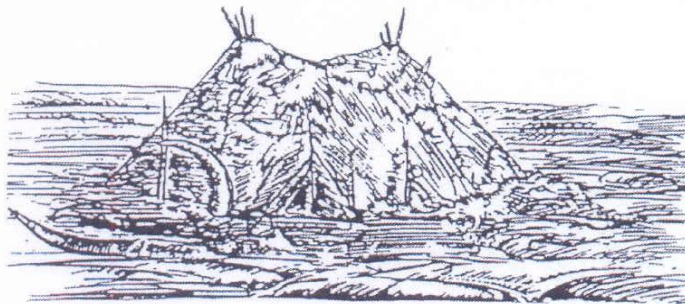

FIGURE01

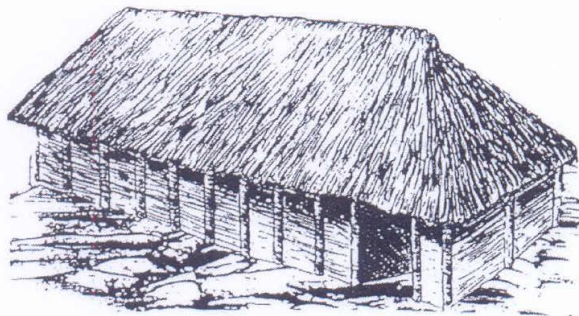

FIGURE 02

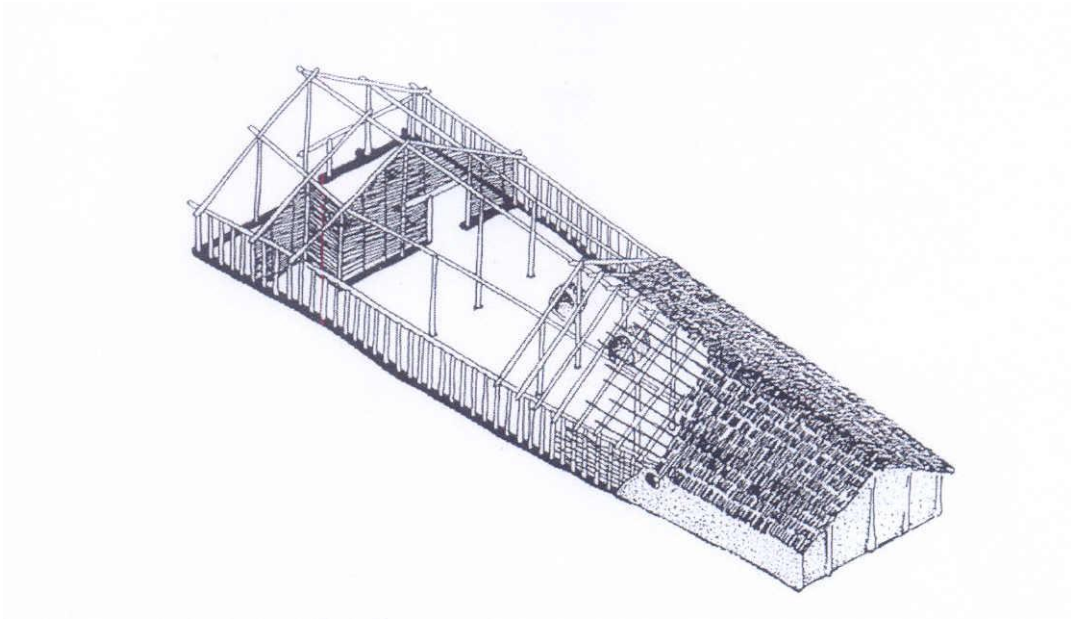

FIGURE 03

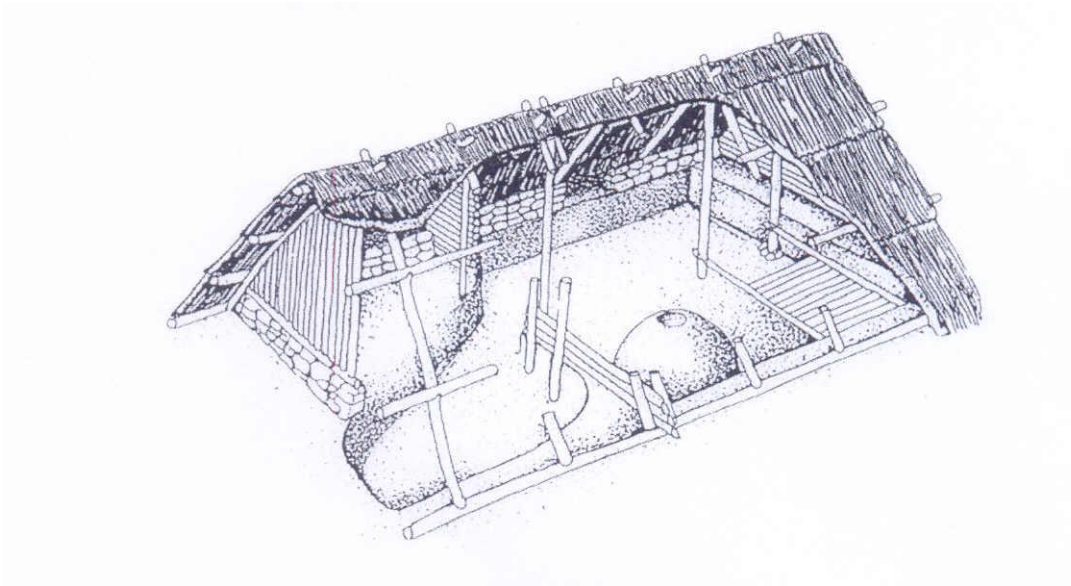

FIGURE 04

Between the 13th and the 15th century , rural architecture came in to existence and in this form existed until the 19th century. The materials used for the houses during this period were timber , stone and clay.

Timber was the first material used for bridge construction and the oldest known bridges go back to 600 BC. The bridge known as Caesar’s Bridge (Figure 05) across the Rhine is believed to have been built under the direction of Vitruvius. In 1570, Andrea Palladio published an illustration of a timber – trussed bridge spanning 30 m over the Cismone River in north-east Italy, which was constructed around 1550 AD (figure 06).

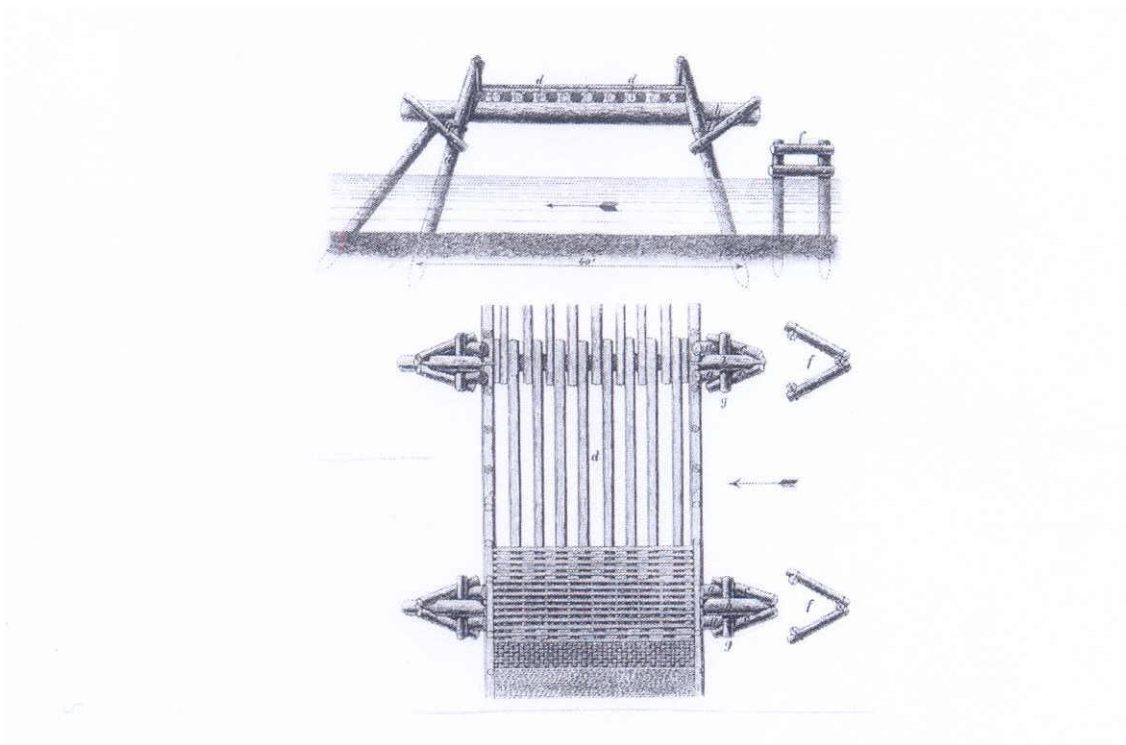

FIGURE 05

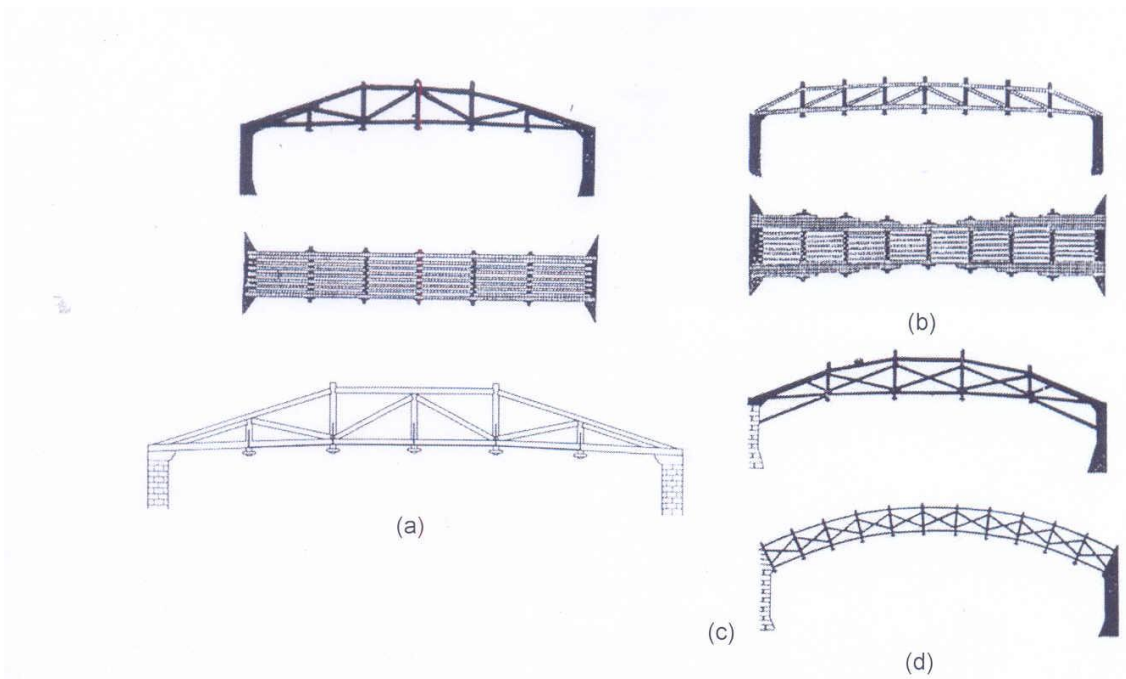

FIGURE 06

2.1 SRI LANKA EXPERIENCE WITH TIMBER

The Sri Lankan experience for timber bridges may also go to the same era. The timber bridge built at Bogoda known as Bogoda bridge has built during the Dambadeniya period. The bridge has been protected from extreme weather conditions by the roof (Figure 07)..



FIGURE 07 –BOGODA BRIDGE -BADULLA

The timber has been turned in to many uses during the ancient days such as buildings with fine decorations, elephant carts , bridges, forts, agricultural tools etc. The following figures shows some evidence. The Embekka Devala is rich with decorated timber columns. This temple has been built by the King Wickramabahu 3rd during 1356 to 1371 under the supervision of well known Architect “ Delmada moolachariya.



FIGURE 08

PILLERS IN EMBEKKA DEVALA



FIGURE 09

PEKADA IN EMBEKKA



FIGURE 10- A WAY SIDE AMBALAMA FOR BHIKKU'S

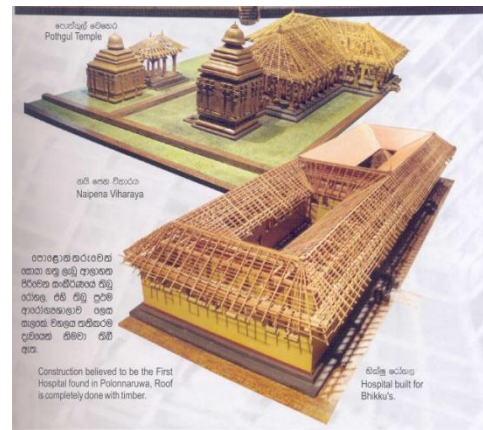

FIGURE 11- HOSPITAL BUILT



FIGURE 12- TRADITIONAL VEHICLES

3.0 USE OF TIMBER IN THE CURRENT INDUSTRY

Timber is now a luxury material in Sri Lanka due to its high cost and the scarcity of large section sizes and lengths. The natural finish that timber gives to house can not be beaten with any new material invented so far. Therefore the demand for the use of timber for housing industry will prevail in the future.

So it is mandatory to invent new technologies to optimise the use of solid hard wood timber which takes years to grove. The medium and light density timber is less expensive but can be used in many applications.

The bending , compressive or tensile stress apply through a timber beam or column section my not be the same . Specially the bending stress of a beam vary from support to the mid span and from top fibre

to bottom fibre. The timber can be used effectively if timber layers of different strength properties are used to form a composite section.

The most common types of timber sections are ply web beams, box columns, spaced beams, lattice columns, timber portals etc.

Some local applications with solid timber and built up sections are shown below.

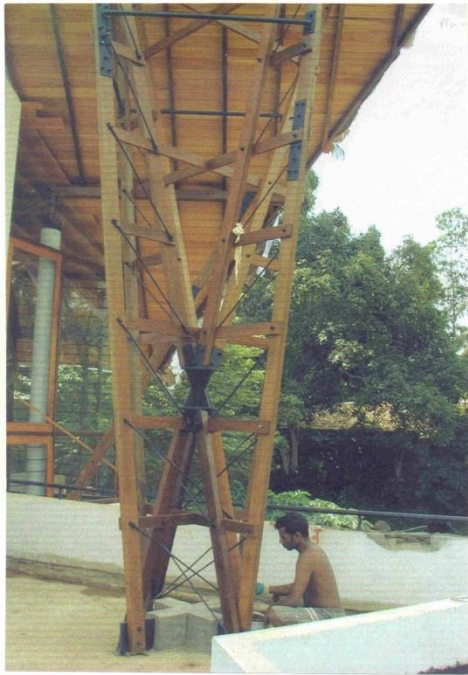

FIGURE 13 –BUILT UP COLUMN PORTALS



FIGURE 14 – SOLID TIMBER COLUMNS AND PORTALS

4.0 FASHIONING WITH TIMBER

Various shapes can be formed with timber while it is been used effectively. When compared to steel plate girders which could be used with variable sections to get optimum use and the beauty of the buildings, timber beams can also be formed to various shapes while providing suitable moment resisting connections.

Our ancestors built wonderful structures using solid hard timber. The heart wood was used to ensure the durability because sap wood could be easily attacked by insects. The challenge of the future Engineers is to use hard and soft wood effectively while not wasting sap wood even for durable structures.

Use of saw dust to form timber elements or ply wood, are best ways to use them effectively in the future. The special characters in timber could still be maintained with this type of systems. Some current uses of such timber elements for elegant buildings are shown in the following figures.



FIGURE 15

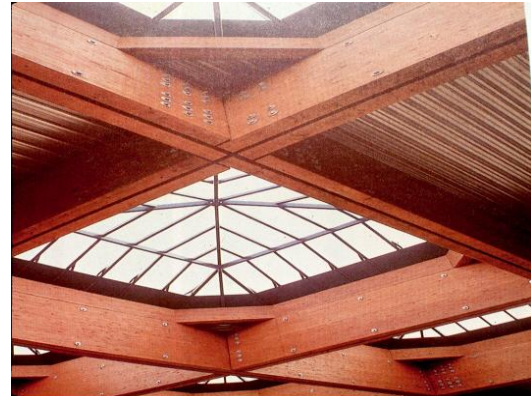

FIGURE 16

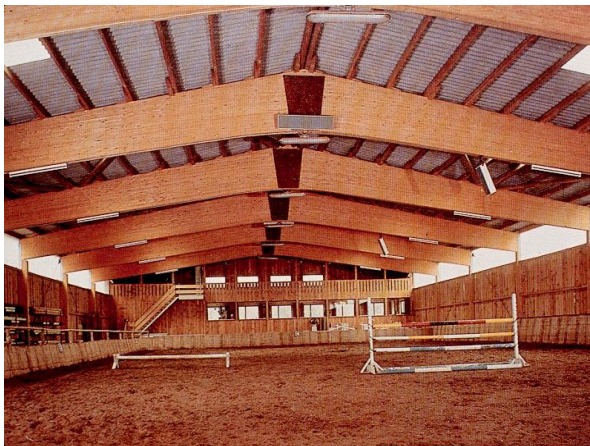

FIGURE 17

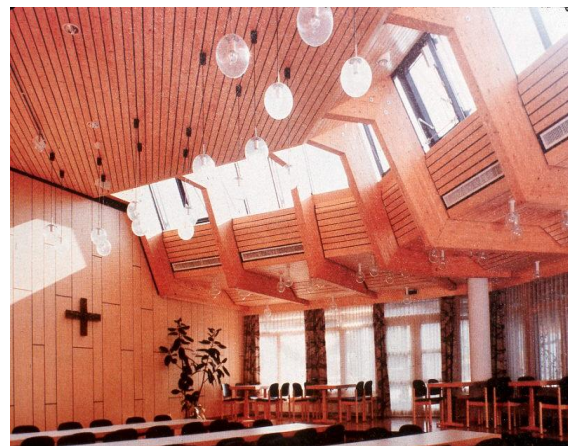

FIGURE 18

5.0 REFERENCES

Dr. Nimal Ruwanpathirana, C K Muthumala (2010), “ Wooden Wonders of Sri Lanka “ published by State Timber corporation.

Petr KUKULIK (2008), “ History of Timber structures ‘ , Czech Technical University in Prague.