

# DEVELOPMENT OF CORRELATION BETWEEN SICK BUILDING SYNDROME AND MICRO-CLIMATE

LIBRARY  
UNIVERSITY OF MORATUWA, SRI LANKA  
MORATUWA

Kahagala Hewage Dayani Nayantha  
128033 K

This thesis submitted in fulfillment requirements for the degree of Master of Philosophy

Department of Civil Engineering

University of Moratuwa  
Sri Lanka

May 2015

Supervised by:

Prof (Mrs.) C. Jayasinghe

Prof S. A. S. Perera

Dr. S. W. Rajapakse

University of Moratuwa



109003

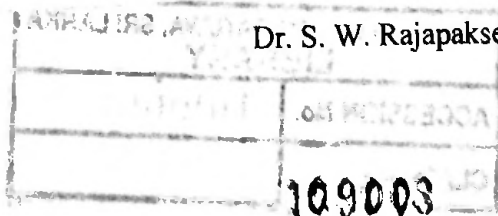

624 "15"  
-----  
624 (043)

109003

+ CD

TH2904

Director/Postgraduate Studies  
Faculty of Engineering  
University of Moratuwa, Sri Lanka.

**DECLARATION**

“I declare that this is my own work and this thesis does not incorporate without acknowledgement any material previously submitted for a Degree or Diploma in any other University or institute of higher learning and to the best of my knowledge and belief it does not contain any material previously published or written by another person except where the acknowledgement is made in the text.

Also, I hereby grant to University of Moratuwa the non-exclusive right to reproduce and distribute my thesis, in whole or in part print, electronic or other medium. I retain the right to use this content in whole or part in future works (such as articles or books).

Signature: ***UOM Verified Signature***

Date: 22/04/2015

The above candidate has carried out research for the MPhil thesis under my supervision.

Signature of the supervisor:

Date:

- |                                    |       |
|------------------------------------|-------|
| 1. Prof (Mrs.) C. Jayasinghe ..... | ..... |
| 2. Prof S. A. S. Perera .....      | ..... |
| 3. Dr. S. W. Rajapakse .....       | ..... |



## ABSTRACT

It has been identified that the incorporation of vegetation in built-environments is a sustainable solution for reducing the energy demand for thermal comfort and air quality in tropical climate and reducing building related stress to improve the human condition. Even though a considerable amount of research has been carried out in order to identify the effect of vegetation on built-environment, hardly any guideline can be found in such incorporation. This study is aimed at the development of guidelines for incorporation of vegetation in built-environments in national scale.

In order to achieve this objective incorporation of vegetation in both indoor and outdoor was studied separately. Initially the effect of the indoor plant on indoor environment was studied in order to quantify the amount of plants to be kept inside a room. This quantification was carried out based on the CO<sub>2</sub> absorption capacity. An equation was developed to determine the amount of leaf area per space, using absorption rate and ventilation rate as parameters. The need for a database of CO<sub>2</sub> absorption rates for varying species was identified consequently.

Framework criteria to develop such database were also identified based on theory, literature review, and experiments. Experiments were carried out in a large-scale chamber with and without plants, and varying several conditions. The identified framework criteria are indoor temperature and relative humidity, lighting source and combinations, orientation of windows, leaf area density per window length, existing CO<sub>2</sub> concentration and night time CO<sub>2</sub> emission. The opinion survey was carried out to identify the public preference towards keeping indoor plants. Majority of the respondents preferred to have indoor plants majorly due to the visual comfort provided by the plants.

Subsequently, incorporation of vegetation in outdoor micro-climates was studied. An experimental study was carried out to measure temperature, relative humidity, CO<sub>2</sub>, NO<sub>2</sub>, and PM<sub>2.5</sub> concentrations in five residential buildings selected based on their micro-climatic features. A parametric study was also carried out using CFD based software, 'ENVI-met' in order to identify strategies to design and plan garden vegetation for residential buildings. The computer models were validated for wind

speed, temperature, CO<sub>2</sub> concentration and wall surface temperatures using field measured data.

It was identified that locating vegetation in northern and southern sides of the building provides the highest beneficial effect on atmospheric temperature and CO<sub>2</sub> concentration where locating vegetation in eastern and western sides provides the highest beneficial effect on wall temperature. It was also identified that the effect of vegetation in the ground level diminishes after a certain height. Thus it was concluded the necessity of the vertical greenery systems in high-rises.

Air pollutant concentration may vary based on vertical elevation. Therefore, a separate study was conducted to evaluate vertical dispersion profiles of several air pollutants. A declining trend of several air pollutants were observed with the building height. A stagnation of air pollutant in street canyons and dense building arrangement was observed. A higher level of air pollution was observed in such arrangements than in locations surrounded by vegetation and water bodies.



## ACKNOWLEDGEMENT

My sincere gratitude is first expressed to my main supervisor; Prof. Mrs. C. Jayasinghe of Department of Civil Engineering, University of Moratuwa for giving me this valuable opportunity to read for a MPhil together with motivation, valuable thoughts and for the continuous guidance provided throughout this research.

I am grateful and indebted to my co- supervisors, Prof. S. A. S. Perera of the Department of Chemical and Process Engineering, University of Moratuwa and Dr. S. W. Rajapakse, medical officer in charge, counselling unit, National Cancer Institute for their helpful suggestions, important advices and constant encouragement during the course of this work.

I am thankful to the members of the Progress review panel (Prof. R. A. Attalage, Dr. Jagath Manatunge, Dr. L. L. Ekanayake) for their continuous monitoring of this research despite their busy schedule and the valuable input provided. I am grateful to Prof. M. T. R. Jayasinghe, Senior professor, University of Moratuwa for his valuable advices given when it is needed. I wish to thank Mr. M. Ekanayaka, the curator of the University of Moratuwa for providing required plants for the study. I also wish to thank all the staff members of the Department of Civil Engineering, who helped me in various ways during the time I spent as a full time research student.

My special thanks go to the Senate Research Grant of University of Moratuwa (Grant no: SRC/LT/2013/1) for creating this opportunity to me by providing financial support during this research study.

I am grateful to Mr. Senaka Wanigarathna and Mrs. N. N. Wijeyrama for their assistance provided on taking permission to carry out experimental work in multi-storied buildings.

I wish to express my deep appreciation to Mr. S. Yathavan, Mr. M. R. M. Rihan, and Mrs. D.S.P.R.D. Premachandra for the assistance given in experimental work. My sincere gratitude for those who participated in the experimental work as occupants and those who supplied valuable data for our questionnaire forms during our study.

I cannot end without thanking my Parents, family members, friends and colleague for their constant encouragement, love and guidance in my life.

## TABLE OF CONTENT

Declaration.....	iii
Abstract.....	iv
Acknowledgement.....	vi
Chapter 1.....	1
1 Introduction.....	1
1.1 General.....	1
1.2 The Objectives.....	5
1.3 The Methodology.....	6
1.4 Arrangement of the report.....	7
Chapter 2.....	8
2 Literature review.....	8
2.1 IEQ and Associated Health Effects.....	8
2.2 Sick building syndrome (SBS).....	11
2.3 Reasons for Poor Indoor Environmental Quality.....	12
2.3.1 Indoor and outdoor sources.....	12
2.3.2 Ventilation rates.....	14
2.3.3 Outdoor air quality.....	14
2.4 Effect of Indoor Plants on Indoor Air Quality.....	16
2.4.1 Absorption of Carbon dioxide.....	20
2.4.1.1 Laboratory-scale chamber studies.....	21
2.4.1.2 Actual studies.....	23
2.4.2 Absorption of Volatile Organic Compounds (VOCs).....	27
2.4.2.1 Actual room studies.....	29
2.4.3 Other air pollutants absorption.....	29

2.4.4	Psychological effect .....	29
2.5	Outdoor micro-climate .....	30
2.5.1	Effect of vegetation on temperature .....	31
2.5.1.1	Quantification of the effect of vegetation .....	31
2.5.2	Effect of vegetation on air quality .....	34
2.5.2.1	Sri Lankan outdoor micro climate study .....	35
2.5.3	Numerical simulation of outdoor micro climate .....	35
2.5.3.1	Quantifying outdoor micro-climatic features .....	38
2.6	Vertical Greening in High-rises .....	39
2.6.1	Vertical profiles of several air quality parameter .....	40
3	Effect of indoor plants on indoor air quality .....	42
3.1	General .....	42
3.2	CO <sub>2</sub> Absorption by indoor Plants .....	43
3.2.1	Simulation of CO <sub>2</sub> concentration inside a mechanically ventilated room 43	
3.3	The Framework Criteria for Experiments on Absorption rates .....	45
3.3.1	Indoor temperature and relative humidity .....	46
3.3.2	Moisture condition of the soil .....	46
3.3.3	Indoor lighting source and lighting level .....	46
3.3.4	Orientation of windows .....	49
3.3.5	Leaf area density .....	50
3.3.5.1	Experimental plant .....	52
3.3.5.2	Experimental procedure .....	52
3.3.5.3	Experimental results .....	56
3.3.6	Existing CO <sub>2</sub> concentration .....	59
3.3.6.1	Experimental procedure .....	62

3.3.6.2	Calculation of the absorption rate .....	62
3.3.6.3	Experimental results .....	64
3.3.6.4	Verification of the absorption rate .....	67
3.3.7	Night-time emission .....	69
3.3.7.1	Experimental procedure .....	69
3.3.7.2	Experimental results .....	70
3.4	Effect of indoor plants on VOC concentration .....	71
3.4.1	Experimental procedure .....	71
3.4.2	Experimental results .....	73
3.5	Opinion Survey on Indoor Plants .....	75
3.6	Summary .....	76
4	Effect of vegetation on outdoor micro-climate .....	77
4.1	Introduction .....	77
4.2	Experimental Study on the Effect of Micro-climate on Thermal Comfort and Air Quality .....	78
4.2.1	Study Location .....	78
4.2.2	Data Collection .....	79
4.2.2.1	Analysis of the vegetative cover .....	80
4.2.3	Results and discussion .....	82
4.2.3.1	Level of indoor environmental quality .....	82
4.2.3.2	Effect of micro-climatic features on air quality parameters .....	83
4.2.3.2.1	Temperature and relative humidity .....	83
4.2.3.2.2	CO <sub>2</sub> Concentration .....	84
4.2.3.2.3	NO <sub>2</sub> Concentration .....	85
4.2.3.2.4	PM <sub>2.5</sub> Concentration .....	86
4.2.3.3	Effectiveness of experimental studies on outdoor micro-climate .....	87



4.3	Computer Simulation of Outdoor Micro-climate.....	89
4.3.1	ENVI-met Software Package .....	89
4.3.1.1	Models in ENVI-met .....	89
4.3.1.2	Structure of ENVI-met.....	90
4.3.1.3	Limitations of ENVI-met.....	91
4.3.2	Study location .....	92
4.3.3	Model development.....	93
4.3.3.1	Spatial and temporal parameters.....	93
4.3.3.2	Buildings and vegetation .....	94
4.3.3.3	Soil profiles.....	96
4.3.3.4	Other input atmospheric parameters .....	98
4.3.4	Model verification.....	99
4.3.4.1	Field measurement.....	99
4.3.4.2	Model verification using wind speed.....	101
4.3.4.3	Model verification using temperature.....	104
4.3.4.4	Model performance in estimating atmospheric CO <sub>2</sub> concentration 106	
4.3.5	Combinations of vegetative cover.....	107
4.3.6	Results and discussion .....	110
4.3.6.1	Atmospheric temperature.....	110
4.3.6.2	Atmospheric CO <sub>2</sub> concentration .....	113
4.3.6.3	Wall temperatures .....	115
4.3.6.4	Verification of the effect of vegetation on wall surface temperature 117	
4.4	Summary .....	121
	Chapter 5 .....	123

5	Vertical profiles of air pollutants for vertical greenery.....	123
5.1	Introduction .....	123
5.2	Experimental Study.....	124
5.2.1	Site description.....	125
5.2.2	Data collection .....	127
5.3	Results and Analysis .....	127
5.3.1	Vertical profile NO <sub>2</sub> concentration.....	127
5.3.2	Vertical profile CO <sub>2</sub> concentration.....	129
5.3.3	Vertical profile PM <sub>2.5</sub> concentration.....	130
5.4	Factors Affecting the Vertical Profile of Air Pollutants .....	131
6	Conclusions.....	133
6.1	Recommendations.....	135
6.2	Future work .....	136
7	References.....	138
	Annex A .....	149
	Annex B .....	150
	Annex C .....	153
	Annex D .....	154
	Annex E .....	155



## LIST OF FIGURES

<b>Figure 1.1:</b> Global and Sri Lankan population growth trends (Source: Sunday Times newspaper [2011, Nov]).....	1
<b>Figure 1.2:</b> (a) – Variation of atmospheric CO <sub>2</sub> concentration for past 50 years (Source: NOAA) , (b) – Global annual-mean surface air temperature change, with the base period 1951-1980(J. Hansen et al. 2001).....	2
<b>Figure 1.3:</b> Number of people living in countries with air quality concentrations above the levels of the NAAQS in 2013 (Source: US EPA) .....	3
<b>Figure 1.4:</b> The inter-relationship of environmental degradation cycle.....	4
<b>Figure 1.5:</b> The methodology flow chart of the study.....	6
<b>Figure 2.1:</b> Arrangement of cells in a plant leaf.....	20
<b>Figure 3.1:</b> CO <sub>2</sub> balance between plant system and surrounding environment .....	43
<b>Figure 3.2:</b> Mass balance of CO <sub>2</sub> inside a mechanically ventilated room.....	44
<b>Figure 3.3:</b> Mass balance of CO <sub>2</sub> inside a mechanically ventilated room with indoor plants .....	44
<b>Figure 3.4:</b> Relative action of photosynthesis in the wave range of PAR (a) and relative sensitivity of human eye in wave range of PAR (b) (Jones 1992).....	47
<b>Figure 3.5:</b> Spectral intensity distribution of different light sources (Source: <a href="http://www.lamptech.co.uk">http://www.lamptech.co.uk</a> ).....	47
<b>Figure 3.6:</b> Representative curves of apparent photosynthesis on sun (solid line) and shade (broken line) species. (Bohning and Burnside 1956).....	49
<b>Figure 3.7:</b> Solar radiation received through the windows facing different directions .....	50
<b>Figure 3.8:</b> Shading of leaves with the increase of leaf area density .....	51
<b>Figure 3.9:</b> Non applicability of leaf area/floor area in plant studies.....	51
<b>Figure 3.10:</b> Plants used in the experiments; Pleomele (a) and Table palm (b).....	53
<b>Figure 3.11:</b> The layout of the test room 1 .....	54
<b>Figure 3.12:</b> The layout of the test room 2.....	54
<b>Figure 3.13:</b> Arrangement of Pleomele plants and data collector in the test room 1 .....	55
<b>Figure 3.14:</b> Arrangement of Table palm and data collector in the test room 2 .....	55
<b>Figure 3.15:</b> Variation of CO <sub>2</sub> concentration for 3 hours with the increase of number of plants for Pleomele .....	57

<b>Figure 3.16</b> : Variation of CO <sub>2</sub> concentration for 6 hours with the increase of the number of plants for Table palm.....	57
<b>Figure 3.17</b> : Reduction in CO <sub>2</sub> concentration with leaf area for Table palm.....	58
<b>Figure 3.18</b> : Reduction in CO <sub>2</sub> concentration with leaf area for Pleomele.....	58
<b>Figure 3.19</b> : Comparative variation of CO <sub>2</sub> absorption of two species .....	59
<b>Figure 3.20</b> : Variation of the rate of photosynthesis with the increase of CO <sub>2</sub> concentration ( <a href="http://www.skool.ie/skool/homeworkzone.asp?id=233">http://www.skool.ie/skool/homeworkzone.asp?id=233</a> ) .....	60
<b>Figure 3.21</b> : Possible variations of absorption rate in the indoor CO <sub>2</sub> concentration range.....	60
<b>Figure 3.22</b> : Temporal CO <sub>2</sub> concentration variation with and without plant.....	63
<b>Figure 3.23</b> : CO <sub>2</sub> variation with time for different concentrations (Pleomele).....	65
<b>Figure 3.24</b> : CO <sub>2</sub> variation with time for different concentrations (Table palm) .....	65
<b>Figure 3.25</b> : The trend lines of the dispersion of CO <sub>2</sub> inside the room (Pleomele)..	66
<b>Figure 3.26</b> : The trend lines of the dispersion of CO <sub>2</sub> inside the room (Table palm)	66
<b>Figure 3.27</b> : Actual and theoretical CO <sub>2</sub> development inside the room due to occupant generation .....	68
<b>Figure 3.28</b> : Actual and theoretical CO <sub>2</sub> development inside the room due to occupant generation with Table palm inside.....	68
<b>Figure 3.29</b> : Nocturnal variation of CO <sub>2</sub> concentration with and without plants .....	70
<b>Figure 3.30</b> : The arrangement of test room 1 .....	72
<b>Figure 3.31</b> : Arrangement of the Pleomele plant and the data collector in the test room 1 .....	72
<b>Figure 3.32</b> : Spraying furniture polish to create a VOC source.....	73
<b>Figure 3.33</b> : Barrier effect on VOC dispersion by indoor plants .....	74
<b>Figure 3.34</b> : VOC dispersion with and without plants for Table palm .....	74
<b>Figure 3.35</b> : Reasons to have plants inside .....	75
<b>Figure 4.1</b> : Site Map of the Study Area .....	79
<b>Figure 4.2</b> : Percentage of micro-climatic features in the Sites .....	81
<b>Figure 4.3</b> : Level of vegetation in the selected sites [(a) – Site 1, (b) – Site 2].....	82
<b>Figure 4.4</b> : Variation of Indoor-outdoor temperature difference with time.....	84
<b>Figure 4.5</b> : Variation of indoor-outdoor RH with time.....	84
<b>Figure 4.6</b> : Variation of Indoor-outdoor CO <sub>2</sub> with time .....	86

<b>Figure 4.7:</b> Variation of NO <sub>2</sub> concentration with time.....	86
<b>Figure 4.8:</b> Variation of PM <sub>2.5</sub> concentration with time.....	87
<b>Figure 4.9:</b> PM <sub>2.5</sub> concentration variation with the distance to the main road .....	87
<b>Figure 4.10:</b> ENVI-met structure (Source: ENVI-met manual).....	92
<b>Figure 4.11:</b> The Google map image of the study area .....	92
<b>Figure 4.12:</b> Vertical grid types specified in the ENVI-met .....	93
<b>Figure 4.13:</b> Obtaining 3-dimensional input coordinates.....	94
<b>Figure 4.14:</b> Defining vegetation in the simulation.....	95
<b>Figure 4.15:</b> Defined model area for ENVI-met simulation building (Ash colour) and vegetation (Green Colour).....	95
<b>Figure 4.16:</b> Soil profiles used in the ENVI-met models.....	97
<b>Figure 4.17:</b> Locations of the climatic measurement stations .....	99
<b>Figure 4.18:</b> Arrangement of the climate measuring stations (a) Station 3 (b) Station 2.....	100
<b>Figure 4.19:</b> Measuring the wind speed in Station 1 .....	101
<b>Figure 4.20:</b> Actual wind speed vs. model wind speed.....	102
<b>Figure 4.21:</b> Modeled wind profile around the building and the observed wind directions (Red arrows) in the stations.....	103
<b>Figure 4.22:</b> Actual temperature and modeled temperature with measured light intensity at station 2 .....	104
<b>Figure 4.23:</b> Actual temperature and modelled temperature with measured light intensity at station 3 .....	105
<b>Figure 4.24:</b> Actual temperature and modelled temperature with measured light intensity at station 4 .....	105
<b>Figure 4.25:</b> Actual CO <sub>2</sub> concentration and modeled CO <sub>2</sub> concentration at station 2 .....	106
<b>Figure 4.26:</b> Actual CO <sub>2</sub> concentration and modelled CO <sub>2</sub> concentration at station 3 .....	107
<b>Figure 4.27:</b> Actual CO <sub>2</sub> concentration and modelled CO <sub>2</sub> concentration at station 4 .....	107
<b>Figure 4.28:</b> The demarcated boundary of the CEC (Red line) .....	108

<b>Figure 4.29:</b> Building and vegetation layout of defined combinations (a- Combination 2, b- Combination 3, c- Combination9, d- Combination10).....	109
<b>Figure 4.30:</b> Outside surface temperature variation of the eastern wall of the building .....	115
<b>Figure 4.31:</b> Outside surface temperature variation of the western wall of the building .....	116
<b>Figure 4.32:</b> Outside surface temperature variation of the northern wall of the building .....	116
<b>Figure 4.33:</b> Outside surface temperature variation of the southern wall of the building .....	117
<b>Figure 4.34:</b> Location of the experimental study (Red circle) .....	118
<b>Figure 4.35:</b> Constructed physical models .....	118
<b>Figure 4.36:</b> Dimensions of the physical models (a- 3D view, b- plan view).....	119
<b>Figure 4.37:</b> Variation of outer surface temperature of eastern wall .....	120
<b>Figure 5.1:</b> Study location .....	124
<b>Figure 5.2:</b> Satellite images of the vicinity of the selected buildings (a-B1, b-B2)	125
<b>Figure 5.3:</b> The layout of the building (B1) .....	126
<b>Figure 5.4:</b> The layout of the building (B2) .....	126
<b>Figure 5.5:</b> Vertical profile of NO <sub>2</sub> concentration in B1 .....	128
<b>Figure 5.6:</b> Vertical profile of NO <sub>2</sub> concentration in B2 .....	128
<b>Figure 5.7:</b> Vertical profile of CO <sub>2</sub> concentration in B1 .....	129
<b>Figure 5.8:</b> Vertical profile of CO <sub>2</sub> concentration in B2 .....	130
<b>Figure 5.9:</b> Vertical profile of PM <sub>2.5</sub> concentration in B1 .....	131
<b>Figure 5.10:</b> Vertical profile of PM <sub>2.5</sub> concentration in B2 .....	131
<b>Figure 6.1:</b> An arrangement for vertical greenery .....	136

## LIST OF TABLES

Table 2-1: Several air pollutants and associated health effects .....	8
Table 2-2: Threshold values for indoor air pollutants recommended by several organizations .....	11
Table 2-3: Indoor and outdoor sources.....	12
Table 2-4: Summary of indoor plants.....	17
Table 2-5: Quantification of CO <sub>2</sub> absorption by different plant species. ....	25
Table 2-6 : Removal of VOCs by several species (Wolverton, Johnson, and Bounds 1989) .....	28
Table 2-7: Comparison of commonly used research methodologies .....	37
Table 3-1: Description of the test rooms .....	53
Table 3-2: Equations to simulate indoor CO <sub>2</sub> concentration for different cases .....	61
Table 3-3: CO <sub>2</sub> absorption rates for two plants for different CO <sub>2</sub> concentration ranges .....	67
Table 4-1: Details of sample sites .....	81
Table 4-2: Recorded range of the air pollutants inside the building .....	83
Table 4-3: Vegetation profiles defined in the ENVI-met.....	96
Table 4-4: Description of input parameters.....	98
Table 4-5: The amount of vegetation provided in different cases as a percentage of opening space .....	109
Table 4-6: The atmospheric temperature difference for different vegetation cases identified .....	111
Table 4-7: Maximum temperature reduction at 1 m height with the reduction of vegetation at different height levels .....	112
Table 4-8: The reduction of atmospheric CO <sub>2</sub> concentration for different vegetation cases identified .....	113

# CHAPTER 1

## 1 INTRODUCTION

### 1.1 General

In the past few decades population growth has been drastically increasing. According to US census bureau the population has doubled from 1960's to 2000. The current global population is about 7 billion. The Sri Lankan population also follows the same trend. Figure 1.1 shows the current trends of the increase of population.

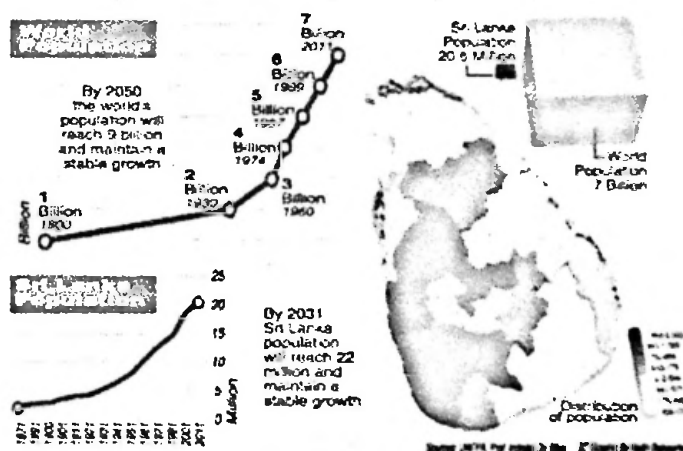
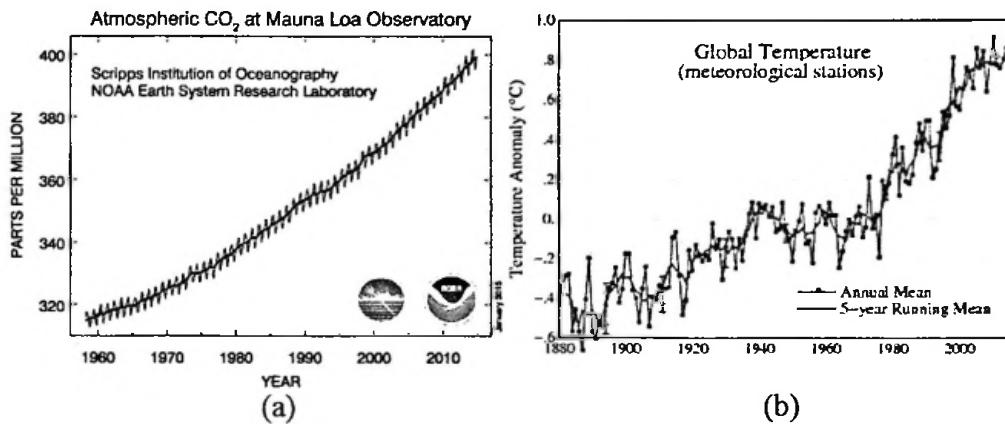

Figure 1.1: Global and Sri Lankan population growth trends (Source: Sunday Times newspaper [2011, Nov])

The exponential population growth also carries with itself the negative consequences of increased resource consumption to support the per capita needs. One of the most adverse effects is the depletion of vegetation that supports multiple ecosystems due to increased demand for habitat. (M. C. Hansen, Stehman, and Potapov 2010) has shown that the loss of forest coverage from 2000 to 2005 is 3.1% (1,011,000 km<sup>2</sup>). The forest department of Sri Lanka has stated that the forest cover in Sri Lanka has reduced from 70% to 24% in the period of 1900-1992.

The most significant effect of vegetation depletion towards air quality and thermal comfort has been the rise of CO<sub>2</sub> concentration. The CO<sub>2</sub> concentration as a greenhouse gas has a latent effect on the rise in global temperature by historically

significant levels. Figure 1.2a shows the global atmospheric CO<sub>2</sub> increase for past 50 years.



**Figure 1.2:** (a) – Variation of atmospheric CO<sub>2</sub> concentration for past 50 years (Source: NOAA), (b) – Global annual-mean surface air temperature change, with the base period 1951-1980 (J. Hansen et al. 2001)

Urbanization has resulted in the increase of the density of manmade structures in a given urban area resulting in the rise of local temperature, well known as “urban heat island” effect. Since the local and global temperatures have risen comparatively with respect to historic values, the need to maintain thermal comfort has resulted in the increase in energy demand. This energy demand will be satisfied by the thermal energy produced by the combustion of fossil fuels. Fossil fuel burning also adversely affects the global CO<sub>2</sub> concentration.

With the dramatic increase of population, it is evident that the need for products and services to sustain quality of life has also increased. For instance an increased need for means of transportation, food and beverage production, and commodity products manufacturing can be observed. These factors will only be supporting the increase of CO<sub>2</sub> concentration which results in the continuation of the negative cycle.

Increased fossil fuel consumption and the depletion of vegetation has not only increased CO<sub>2</sub> concentration, but also resulted in various air pollutants to be introduced to the atmosphere in undesirable levels. All these negative environmental factors have adversely affected human health condition which is a serious consequence. According to United State Environmental Protection Agency, 75.4

millions of people are exposed to the pollutant concentration above the threshold values recommended by US National ambient air quality standards (NAAQS).

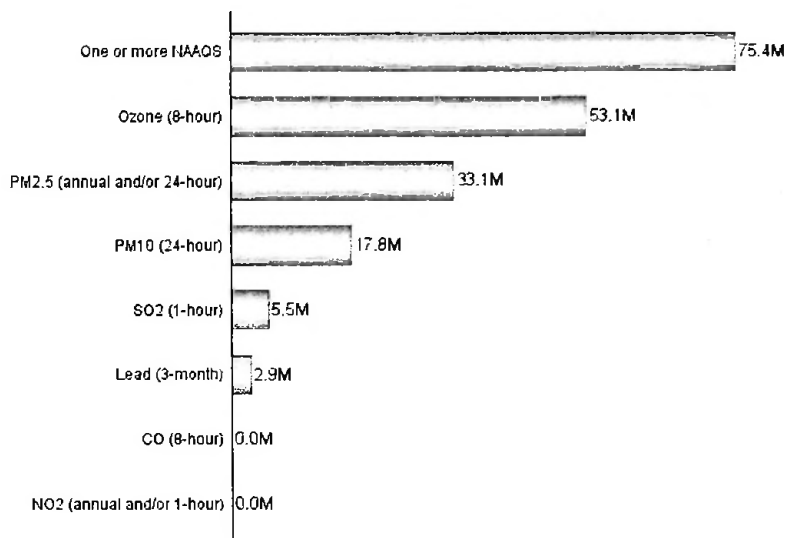
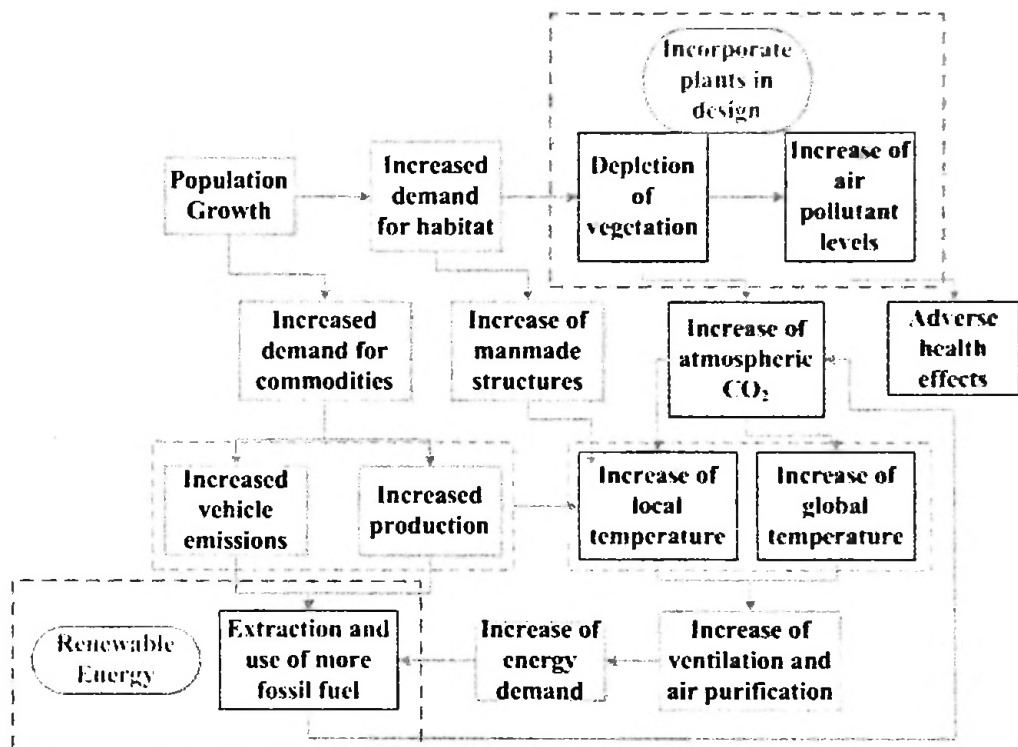

**Figure 1.3:** Number of people living in countries with air quality concentrations above the levels of the NAAQS in 2013 (Source: US EPA)

The figurative explanation for these relationships have been developed as illustrate inFigure 1.4.

However, the implementation of a higher degree of renewable energy usage, increasing the incorporation of vegetation in built-environments, and utilizing sustainable practices in designing and planning built-environments can reverse this adverse cycle. Thus this study was carried out to investigate on including vegetation in indoor and outdoor environments to create favourable micro-climates.





**Figure 1.4:** The inter-relationship of environmental degradation cycle

For past few decades studies have been carried out on inclusion of vegetation in built-environment. The abilities to purify the air and reduce the atmospheric temperature have been identified qualitatively and quantitatively. However, incorporation of these findings in design and planning guidelines is still in the infancy stage. Hence this study is aimed at identifying such guidelines and frameworks in national scale.

In this study incorporation of vegetation in three levels has been identified to be discussed. The first level is incorporation of vegetation in indoor as indoor plants. Even though several studies have shown the beneficial effects of indoor plants, hardly any can be utilized to develop guidelines. Identifying this research need, the main focus has been given to develop a framework for such guidelines.

In Sri Lanka, it has been identified that the suburban area is becoming the main attraction for residential development. It is well known that suburban vegetation has a direct impact on balancing the urban thermal condition and the environmental

pollution. Hence unplanned replacement of sub-urban vegetation by man-made structures can adversely affect the thermal comfort and air quality in both urban and suburban environment. Hence another research need was identified on incorporation of vegetation in terms of amount and placement in residential development.

In previous studies it has been shown that the ground level vegetation has a minimal effect or an adverse effect on atmospheric conditions in urban areas where lot of high-rises are present. Thus the vertical greenery seems to be an option for such buildings. In order to assist in developing effective vertical greenery systems the knowledge on vertical dispersion of air pollution is required. Thus this study is also aimed on studying the vertical dispersion of air pollutants in the urban areas.

## **1.2 The Objectives**

The main objective of this study is to investigate on incorporation of vegetation in built-environment based on micro-climate and elevation in order to improve the indoor environmental quality (IEQ) and reduce the sick building syndrome (SBS). The sub-objectives to be achieved under this study were identified as;

1. To investigate the effects of indoor plants on indoor air quality and identify the factors affecting the performance.
2. To investigate the effects of different magnitudes of vegetation on outdoor air quality and temperature.
3. To determine the relationship between air quality and elevation as a factor of vertical greenery systems.
4. To proposes frameworks and guidelines for incorporation of vegetation in built-environments

### 1.3 The Methodology

The methodology flow chart for this study has been shown in Figure 1.5.

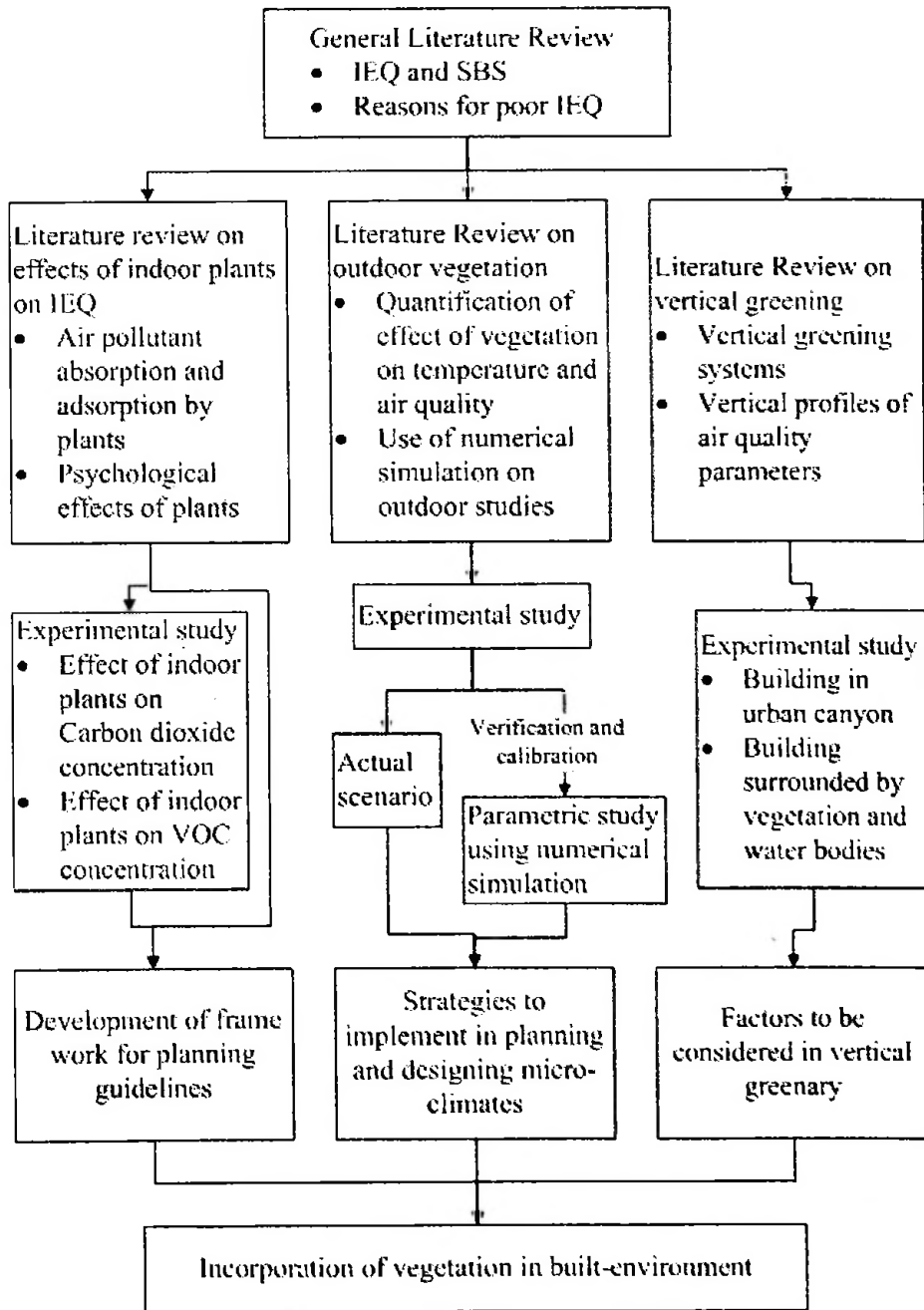

Figure 1.5: The methodology flow chart of the study

IEQ – Indoor environmental quality

SBS – Sick building syndrome

#### 1.4 Arrangement of the report

- Chapter 1 Introduction:** Presents the background and the problem statement of the study, states the objectives and outlines the approach used in the research.
- Chapter 2 Literature review:** Covers the relevant literature on indoor environmental quality and associated health effects, indoor plants and quantification of the effects, qualitative and quantitative effect of vegetation on outdoor micro-climate, vertical greenery systems, and current vertical profiles of air quality. This also presents the indoor plants that have proven to purify the indoor air.
- Chapter 3 Effect of indoor plants on indoor air quality:** Illustrates the theoretical developments and experimental procedure carried out in order to investigate the factors affecting the performance of indoor plants. A framework for indoor plants was concluded in this chapter.
- Chapter 4 Effect of vegetation on outdoor micro-climate:** Initially describes the experimental procedure carried out for situational analysis of sub urban area. Subsequently, this illustrates the development of micro-climate simulation, experimental procedure for results verification and strategies that can be adopted for better outdoor micro-climate.
- Chapter 5 Vertical profiles of air pollutants for vertical greenery:** Illustrates the experimental procedure carried out in order to investigate the vertical dispersion of air pollutants in two different urban morphologies.
- Chapter 6 Conclusions:** Explains the main findings and conclusions from this study. The future work also has been given here.

## CHAPTER 2

### 2 LITERATURE REVIEW

Indoor environmental quality (IEQ) is a widely discussed topic due to the severances of the health effects caused by poor IEQ. A considerable number of researches has been carried out in order to investigate the IEQ under various conditions and to find out the means to improve the IEQ. This chapter presents a detailed review on such studies related to indoor plants, outdoor micro climate and vertical greening.

#### 2.1 IEQ and Associated Health Effects

Previous studies have reported that urban residents spend more than 80% of their whole day indoors despite their busy and diversified lifestyles. Thus presence of air pollutants can adversely affect the health conditions of tenants. Adverse health effects caused by over exposure to such air pollutants according to World Health Organization (WHO) and several studies have been shown in the Table 2-1.

**Table 2-1:** Several air pollutants and associated health effects

Air pollutant	Exposure condition	Health effects	Reference
Carbon Dioxide (CO <sub>2</sub> )	>1000 ppm	Occurrence of Sick building syndrome	(Fisk et al. 2002; Gupta, Khare, and Goyal 2007a; Wong and Huang 2004a)
Carbon Monoxide (CO)	Chronic(>24hrs) Low- level	Hearing deficiency, Poisoning (fatigue, headache, vertigo, irritation, memory impairment, tinnitus, nausea), Neuronal dysfunction, Low birth weight, Congenital defects, Defects in Infant and adult mortality, Cardiovascular effects, Asthma, Tuberculosis, Pneumonia	(WHO 2012)

	Acute(<24hrs)	Headache, dizziness, weakness, nausea and chest pain, shortness of breath, vomiting, muscle cramps, difficulty in concentrating, visual changes and confusion (cognitive difficulties and personality changes)	
Nitrogen Dioxide (NO <sub>2</sub> )	188-360 µg/m <sup>3</sup>	Respiratory diseases- wheeze, asthma Bronchoconstriction Increased bronchiole reactivity Airway inflammation	(WHO 2012)
	380-560 µg/m <sup>3</sup>	Decrease in immune defense systems	
Particulate Matter (PM)	10-20 µg/m <sup>3</sup>	Association has been found in atmospheric PM concentration and premature death.	(Green and Armstrong 2003)
Benzene	<1 ppm long term exposure	Reduction in red and white blood cells	(WHO 2012)
	15-30 ppm for more than 4 months	Potential risk of leukopenia, thrombocytopenia, eosinophilia and pancytopenia and changes in bone marrow	
	50-100 ppm for 30 minutes	Fatigue and headaches	
	250-500 ppm 30 minutes	Dizziness, headaches, faintness and nausea	
	20,000 ppm for 5-10 mins	Fetal	
	High risk of leukaemia, including myeloid leukaemia even for long term exposure low concentration such as 1 ppm for about 5 years Potential risk of DNA damage also has been found		
Formaldehyde	0.63 mg/m <sup>3</sup>	Trigeminal stimulation of the eyes	(WHO 2012)
	0.38 mg/m <sup>3</sup> for 4 hrs	Sensory irritation	
	10-13mg/m <sup>3</sup>	Effect on bone marrow and blood progenitor cells, Lymphohematopoetic malignancies	
	High exposure	Nasopharyngeal malignancies and leukemia	
Naphthalene		Haemolytic anemia	(WHO 2012)
Polycyclic aromatic carbon	100 ng/m <sup>3</sup>	Intrauterine growth restriction Bronchitis, asthma and asthma- like symptoms	(WHO 2012)

	0.04 - 40 $\mu\text{g}/\text{m}^3$	Lung cancer, Bladder and urinary tract tumors, Breast cancer, DNA damage	
	>1.0ng/m <sup>3</sup>	Fatal ischaemic heart disease	
Radon		Lung cancer Association with other cancers eg. Leukemia, DNA damage	(WHO 2012)
Trichloroethylene	600–1000 mg/m <sup>3</sup>	Neurological damage	(WHO 2012)
	18–683 mg/m <sup>3</sup>	Cardiac effects and death Immune disorders- autoimmunity Hepatic effects Developmental effects- cardiac and eye malformation Cancers associate with liver kidney and bile duct Non-Hodgkin's lymphoma	
Tetrachloroethylene	100-200ppm (Short term exposure)	Irritation of the skin, eyes and upper respiratory tract	(WHO 2012)
	50-300ppm (Short term exposure)	Non- cardiogenic pulmonary oedema, nausea, vomiting, diarrhea and CNS effects	
	> 100ppm	Neurological symptoms	
	50ppm	Visual system dysfunction	
	21ppm	Abnormal liver functions	
	10ppm	Renal effects Reproductive and developmental defects Oesophagal and cervical cancers and Non-Hodgkin's lymphoma	

Several organizations have defined threshold values for those air pollutants based on the toxicity and the availability of these air pollutants. Those threshold values can be found in the Table 2-2.

**Table 2-2:** Threshold values for indoor air pollutants recommended by several organizations

Pollutant Name	Threshold Limit	Organization
CO <sub>2</sub>	1000 ppm	ASHRAE(2005)
NO <sub>2</sub>	0.053 ppm 24-hour mean	US EPA (2010)
CO	9 ppm	US EPA (1994)
VOC	0.75 ppm	OSHA (1992)
PM <sub>2.5</sub>	25 µg/m <sup>3</sup> 24-hour mean	WHO (2005)

*Note:*

*ASHRAE – American Society of Heating, Refrigerating and Air-conditioning Engineers*

*US EPA – United States Environmental Protection Agency*

*OSHA – Occupational Safety and Health Administration*

## 2.2 Sick building syndrome (SBS)

Apart from the specific health effects that have been revealed, nonspecific health discomforts have been reported among the tenants who were exposed to poor IEQ. Some of these discomforts are allergic reactions, headache, lethargy, skin irritation, sore eyes, runny nose, sore throat, dizziness, nausea etc (Gupta, Khare, and Goyal 2007b; Leyten and Kurvers 2006; Norhidayah et al. 2013; Redlich, Sparer, and Cullen 1997; Rios et al. 2009; Stenberg et al. 1994). In various countries a considerable number of research has been carried out, as SBS has resulted in increased absenteeism and decreased work productivity in offices (Norhidayah et al. 2013; Singh 1996; Stenberg et al. 1994).

A study that has been carried out in 260 Japanese residential units, has found an increased levels of indoor aldehydes and aliphatic hydrocarbons. Those units were newly built units which were only less than 7 years in age at the time of investigation. They have found that approximately 12-14% have been subjected to the sick building syndrome which can be correlated to the increase of air pollutant levels inside (Takigawa et al. 2012). Table 2-1 has shown that the occupants who were exposed to high CO<sub>2</sub> concentration have suffered from SBS. However another

study carried out in US office buildings has shown the prevalence of SBS in the CO<sub>2</sub> concentration less than 1000 ppm (Apte, Fisk, and Daisey 2000).

Even though the main reason for SBS has found to be the poor indoor quality (Gupta, Khare, and Goyal 2007b; Rios et al. 2009), according to Hedge, there can be other factors besides the air quality level such as fluorescent lighting, video displays and job stress (Rotton and White 1996). In another study it has been found that daylighting, electric lighting and glare as tenants' dissatisfying factors (Kamaruzzaman et al. 2011). It has been identified that building, social and personal factors can influence one's perceived health and comfort (Bluyssen, Aries, and van Dommelen 2011). Thus it can be concluded that using the SBS score to rate the IEQ might not be reliable.

### 2.3 Reasons for Poor Indoor Environmental Quality

Several reasons can be identified for poor IEQ in buildings. The main reasons for poor IEQ are described in following sections.

#### 2.3.1 Indoor and outdoor sources

There are several sources that emit air pollutants to the atmosphere. Those can be categorized as outdoor sources and indoor sources. The list of indoor and outdoor sources has shown in the Table 2-3.

**Table 2-3: Indoor and outdoor sources**

Pollutant	Sources	
	Indoor	Outdoor
Benzene	<ul style="list-style-type: none"> <li>• Vinyl, PVC, and rubber flooring</li> <li>• Particleboard furniture, plywood and fibreglass</li> <li>• Flooring adhesives, paints, caulking and paint remover</li> <li>• Consumer products like cleaning, air fresheners, mosquito repellent</li> <li>• Printing and photocopying</li> <li>• Environmental tobacco smoke</li> </ul>	<ul style="list-style-type: none"> <li>• Petrol stations</li> <li>• Coal, oil, natural gas, chemical and steel industries</li> </ul>
Carbon monoxide	<ul style="list-style-type: none"> <li>• Cooking or heating appliances that burn fossil fuel</li> <li>• Environmental tobacco smoke</li> <li>• Clogged chimneys, attached garages</li> </ul>	<ul style="list-style-type: none"> <li>• Petrol or diesel powered motor vehicles</li> </ul>

Formaldehyde	<ul style="list-style-type: none"> <li>• Cooking, smoking, heating, candle or incense burning</li> <li>• Particleboard, plywood and fibreboard</li> <li>• Insulating materials</li> <li>• Textiles</li> <li>• Paints, adhesives, glues, varnishes</li> <li>• Detergents, softeners</li> <li>• Liquid soaps, shampoo, nail varnishes and nail hardeners</li> <li>• Computer, photocopiers</li> <li>• Insecticides and paper products</li> </ul>	
Naphthalene	<ul style="list-style-type: none"> <li>• Synthesis of phthalate plasticizers and synthetic resins</li> <li>• Ingredients for Plasterboards</li> <li>• As dispersants in rubber and as tanning agents in leather</li> <li>• Paints</li> <li>• Insecticides, moth repellents and disinfectant</li> <li>• Solid block deodorizer for toilets</li> <li>• Smoke of wood</li> <li>• Combustion of fuel oil and gasoline</li> <li>• Constituent for timber impregnation</li> <li>• Unvented kerosene heaters and tobacco smoke</li> </ul>	<ul style="list-style-type: none"> <li>• Fugitive emissions and motor vehicle exhaust</li> <li>• Spills to land and water during storage, transport and disposal of fuel oil and tar</li> <li>• Heavy traffic, petrol stations and oil refineries</li> </ul>
Nitrogen Dioxide (NO <sub>2</sub> )	<ul style="list-style-type: none"> <li>• Tobacco smoke</li> <li>• Gas, wood, oil, kerosene and coal burning appliances such as stoves, ovens, space and water heaters and fire places</li> </ul>	<ul style="list-style-type: none"> <li>• Road traffic</li> </ul>
Polycyclic aromatic carbon	<ul style="list-style-type: none"> <li>• Smoking</li> <li>• Cooking</li> <li>• Heaters with fuel stoves and open fireplaces</li> <li>• Incense and candle emissions</li> </ul>	<ul style="list-style-type: none"> <li>• Emission from road traffic</li> <li>• Power generation plants</li> <li>• Waste incinerators</li> <li>• Open burning</li> </ul>
Radon	<ul style="list-style-type: none"> <li>• Decay of radium in the soil subjacent to a house</li> <li>• Water supplies</li> </ul>	<ul style="list-style-type: none"> <li>• Land masses</li> <li>• Sea water</li> </ul>
Trichloroethylene	<ul style="list-style-type: none"> <li>• Contaminated water from washing machines and dishwashers</li> <li>• Wood stains, varnishes, lubricants, certain cleaners</li> <li>• Dairy products and margarine</li> </ul>	
Tetrachloroethylene	<ul style="list-style-type: none"> <li>• Fatty food products</li> <li>• Synthetic water pipes and contaminated drinking water</li> <li>• Dry cleaning facilities</li> <li>• Polluted soil</li> </ul>	



### **2.3.2 Ventilation rates**

With the emergence of the concern regarding the energy crisis in 1971, air exchange between indoors and outdoors was limited in mechanically ventilated buildings to reduce the energy used for thermal comfort. As a result, indoor air quality has deteriorated drastically due to the stagnation of air pollutants inside buildings. The lower ventilation rates are found to be one of the main causes for sick building syndrome (Milton, Glencross, and Walters 2000; Norhidayah et al. 2013; Redlich, Sparer, and Cullen 1997; Rios et al. 2009; Stenberg et al. 1994). A study carried out in several residential units in Singapore has shown a higher records of SBS symptoms in air conditioned units than that in naturally ventilated units (Wong and Huang 2004a). The CO<sub>2</sub> concentration inside the air conditioned units are also higher (>1000 ppm) than that in naturally ventilated units. Eventhough a clear relationship has not been established between SBS and CO<sub>2</sub> concentration, it should be noted that higher CO<sub>2</sub> level indicates the lower ventilation rates inside the space.

Mechanical ventilation systems used in Sri Lanka are of two types; namely centrally air conditioned systems and split air conditioned systems. In centrally air conditioned buildings, CO<sub>2</sub> based Demand Controlled Ventilation (DCV) strategies have been used. This has enabled to preserve the indoor air quality while providing the required thermal comfort by controlling the fresh air supply (Lü et al. 2013; Sun, Wang, and Ma 2011; Mysen et al. 2005). However, in split unit systems no such method of supplying controlled fresh air is facilitated considering the energy cost. This results indoor air pollutants concentration to rise and exceed the threshold values in buildings which are air conditioned using split units due to considerably low ventilation rates(Wong and Huang 2004b). A common problem of converting the naturally ventilated buildings to mechanically ventilated ones without proper modifications in ventilation systems has been identified in tropical countries.

### **2.3.3 Outdoor air quality**

Since the air enters a room from outside, the outdoor air quality plays a major role in indoor environmental quality. In naturally ventilated buildings outdoor air directly penetrates inside where in mechanically ventilated buildings outdoor air is supplied inside through ducts and vents.

Lower the outdoor air temperature, lower the energy required to keep thermal comfort inside has been observed. With lower outdoor temperature a higher fraction of outdoor air can be provided in to the building. Furthermore, it is well understood that the low air pollutant concentration in outdoor directly results in better indoor air quality.

#### 2.4 Effect of Indoor Plants on Indoor Air Quality

There are three common ways to improve indoor air quality; these include source control, good ventilation systems to exhaust contaminated air, and air cleaning. Indoor pollutant sources can be controlled only up to a certain level. For an example, usage of air freshener can be avoided to minimize the VOC concentration where the CO<sub>2</sub> generation by the occupants cannot be avoided. As of now, optimizing the ventilation in the building is the commonly used method (Nassif 2012; Mysen et al. 2005; Sun, Wang, and Ma 2011). Still the energy cost required is considerable. Methods of low energy required on air cleaning include photocatalytic oxidation (Zhao and Yang 2003), photo-electrochemical approach, photosynthetic bioreactor, structural composite hybrid systems and adsorption by using plants (Yarn et al. 2013).

Among all other measurements that have been taken to increase the indoor air quality, indoor plants are gaining popularity because of its many advantages. Mainly the use of indoor plants is beneficial in reducing elevated CO<sub>2</sub> levels as plants use up CO<sub>2</sub> for photosynthesis. Moreover studies show that plants have the ability to absorb several other pollutants in the air as well.

In early studies, mainly two types of focus can be found namely, laboratory-scale chamber studies and actual-scale studies. The most common method of indoor plants studies is to measure the pollutant concentration with time in a small transparent glass chamber while keeping the plant inside. In some studies, the initial concentration was elevated up to a certain level and then has been left to disperse. In actual scale studies, pollutant concentration inside a real space has been measured without plants and with plants as a comparison. Eventhough these studies reveal that the specific plant species have the CO<sub>2</sub> absorption potential, the number of plants to be kept in another location cannot be derived easily.

Lately with the development of computer aided simulation methods, the chamber studies have been combined with the numerical models where actual size physical models cannot be made, i.e. studies done along a street canyon. This can be mainly

found in outdoor studies. A summary of the plants which have shown favourable performance is listed in the Table 2-4.

**Table 2-4:** Summary of indoor plants

Name	Scientific name	Air quality performance	Citation
Aloe vera		Formaldehyde	(Wolverton, Johnson, and Bounds 1989)
areca palm	<i>Chrysalidocarpus lutescens</i>	CO <sub>2</sub>	(Oh et al. 2011)
Chinese evergreen	<i>Aglaonema modestum</i>	Benzene, Formaldehyde	(Wolverton, Johnson, and Bounds 1989)
Aloe type	<i>Apicra deltoidea</i>	CO <sub>2</sub>	(Raza 1995)
Bird's nest fern	<i>Asplenium nidus</i>	CO <sub>2</sub>	(Su and Lin 2013)
Michaelmas Daisy	<i>Aster amellus</i>	CO <sub>2</sub>	(Raza 1995)
Annual daisy	<i>Bellis annua</i>	CO <sub>2</sub>	(Raza 1995)
Air plant	<i>Bryophyllum calycinum</i>	CO <sub>2</sub>	(Raza 1995)
Air plant	<i>Bryophyllum pinnata</i>	CO <sub>2</sub>	(Raza 1995)
Bamboo palm	<i>Chamaedorea seifritzii</i>	TCE, Benzene, Formaldehyde	(Wolverton, Johnson, and Bounds 1989)
Green spider plant	<i>Chlorophytum elatum</i>	Formaldehyde	(Wolverton, Johnson, and Bounds 1989)
Indian chrysanthemum	<i>Chrysanthemum indicum</i>	CO <sub>2</sub>	(Raza 1995)
Pot mum	<i>Chrysanthemum morifolium</i>	Benzene	(Wolverton, Johnson, and Bounds 1989)
Citron	<i>Citrus medica</i>	Benzene	(Liu et al. 2007)
Spoon Jade	<i>Crassula</i>	Benzene	(Liu et al. 2007)

Name	Scientific name	Air quality performance	Citation
	<i>portulacea</i>		
Orchid type	<i>Cymbidium Golden Elf</i>	Benzene	(Liu et al. 2007)
Type of pot mum	<i>Dendranthema morifolium</i>	Benzene	(Liu et al. 2007)
Dumbcane	<i>Dieffenbachia amoena</i>	Benzene	(Liu et al. 2007)
Janet Craig	<i>Dracaena deremensis</i>	TCE, Benzene, Formaldehyde	(Wolverton, Johnson, and Bounds 1989) (Liu et al. 2007)
Janet Craig	<i>Dracaena deremensis</i>	CO <sub>2</sub>	(Pegas et al. 2012)
Warneckei	<i>Dracaena deremensis</i>	TCE, Benzene	(Wolverton, Johnson, and Bounds 1989)
Red-edged dracaena	<i>Dracaena marginata</i>	TCE, Benzene, Formaldehyde	(Wolverton, Johnson, and Bounds 1989)
Red-edged dracaena	<i>Dracaena marginata</i>	CO <sub>2</sub>	(Pegas et al. 2012)
Mass cane	<i>Dracaena massangeana</i>	TCE	(Wolverton, Johnson, and Bounds 1989)
Pothos	<i>Epipremnum aureum</i>	Benzene	(Burchett, Torpy, and Brennan 2009)
Weeping fig	<i>Ficus benjamina</i>	CO <sub>2</sub>	(Oh et al. 2011)
	<i>Ficus microcarpa</i>	Benzene	(Liu et al. 2007)
Gerbera daisy	<i>Gerbera jamesonii</i>	TCE, Benzene	(Wolverton, Johnson, and Bounds 1989)
English ivy	<i>Hedera helix</i>	TCE, Benzene, Formaldehyde	(Wolverton, Johnson, and Bounds 1989)
Bigleaf hydrangea	<i>Hydrangea macrophylla</i>	Benzene	(Liu et al. 2007)

Name	Scientific name	Air quality performance	Citation
Jungle geranium	<i>Ixora coccinea</i>	CO <sub>2</sub>	(Raza 1995)
Conferta	<i>Juniperus conferta</i> <i>parl</i>	CO <sub>2</sub>	(Fujii et al. 2005)
Penwiper	<i>Kalanchoe</i> <i>marmorata</i>	CO <sub>2</sub>	(Raza 1995)
Banana	<i>Musa oriana</i>	Formaldehyde	(Wolverton, Johnson, and Bounds 1989)
Sword fern	<i>Nephrolepis</i> <i>exaltata</i>	Benzene	(Liu et al. 2007)
Pepper elder	<i>Pepromia pellucida</i>	CO <sub>2</sub>	(Raza 1995)
Elephant ear philodendron	<i>Philodendron</i> <i>domesticum</i>	Formaldehyde	(Wolverton, Johnson, and Bounds 1989)
Heart leaf philodendron	<i>Philodendron</i> <i>oxycardium</i>	Formaldehyde	(Wolverton, Johnson, and Bounds 1989)
Snake plant	<i>Sansevieria</i> <i>laurentii</i>	TCE, Benzene, Formaldehyde	(Wolverton, Johnson, and Bounds 1989)
	<i>Sansevieria</i> <i>trifasciata</i>	Benzene	(Burchett, Torpy, and Brennan 2009)
Golden pothos	<i>Scindapsus aureus</i>	Formaldehyde	(Wolverton, Johnson, and Bounds 1989)
Golden pothos	<i>Scindapsus aureus</i>	Increase in CO <sub>2</sub>	(Burchett, Torpy, and Brennan 2009)
Many fingers	<i>Sedum</i> <i>pachyphyllum</i>	CO <sub>2</sub>	(Raza 1995)
Peace lily	<i>Spathiphyllum</i> <i>clevelandii</i>	CO <sub>2</sub>	(Wolverton, Johnson, and Bounds 1989, Oh et al. 2011, Pegas et al. 2012)
	<i>Spathiphyllum</i> <i>Supreme</i>	Benzene	(Liu et al. 2007)
Arrowhead vine	<i>Syngonium</i> <i>podophyllum</i>	VOC, CO <sub>2</sub>	(Irga, Torpy, and Burchett 2013)
Zanzibar Gem	<i>Zamioculcas</i> <i>zamiifolia</i>	Benzene	(Burchett, Torpy, and Brennan 2009)

A detailed analysis of the performance of some plants is discussed separately in the following sections.

### 2.4.1 Absorption of Carbon dioxide

Plants utilize  $\text{CO}_2$  and produce nutritive elements used by other living beings for survival. This process is known as photosynthesis. The expanded reaction of photosynthesis is;

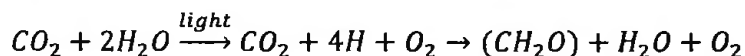

This process takes place inside of a plant cell known as chloroplast. The  $\text{CO}_2$  is transferred to chloroplast from the general atmosphere through the stomata of the leaf. Figurative cross section of a leaf can be found in the Figure 2.1.

It can be seen that photosynthesis can be divided into two reactions, depending on the light requirement. The first reaction is termed as *light reaction* which divides  $\text{H}_2\text{O}$  molecule into  $\text{H}_2$  and  $\text{O}_2$  molecules. This happens only in the presence of light energy. The second reaction is termed as *dark reaction* which produces carbohydrates with the use of  $\text{CO}_2$ . For this process no light energy is required.

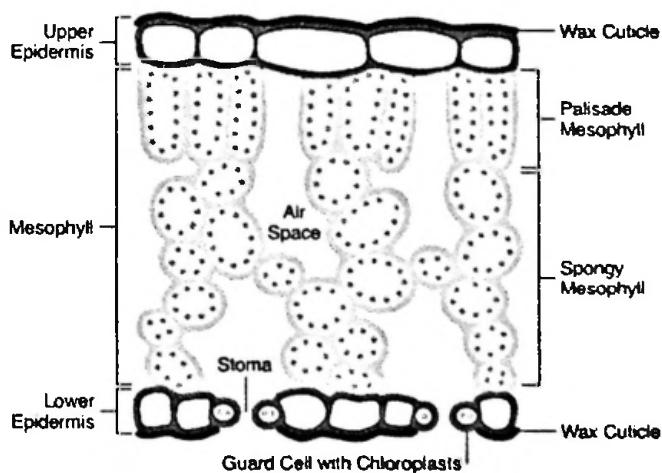

**Figure 2.1:** Arrangement of cells in a plant leaf

(Source: [http://www.bbc.co.uk/schools/gcsebitesize/science/add\\_aqa\\_pre\\_2011/plants/plants1.shtml](http://www.bbc.co.uk/schools/gcsebitesize/science/add_aqa_pre_2011/plants/plants1.shtml))

Depending on the path ways of fixation of CO<sub>2</sub>, three types of plants can be identified.

1. C<sub>3</sub> plants – This is the pathway found commonly in trees with few exceptions and in large number of crop species.
2. C<sub>4</sub> plants – These are common in tropical and semi-arid zone including cereals maize, millet and sorghum. It has the adaptability to hot dry environments.
3. CAM plants – These plants are mainly succulent plants such as cacti, pineapple, sisal etc. The specific feature of these plants is the opening of the stomata during night time and closing in the day time where as in every other plant it is the other way around. Because of this feature CO<sub>2</sub> absorption can be observed in the night time in these types of plants.

A large collection of literature can be found for models of photosynthesis in the fields of crop growth and carbon sequestration by the forest. Comparatively very few studies have been carried out to evaluate the use of plants as indoor CO<sub>2</sub> sinks.

CO<sub>2</sub> sequestration by outdoor plants and forests is well studied and well documented (Gratani and Varone 2007a). The studies that have been carried out to find the effect of indoor plants on CO<sub>2</sub> absorption have been discussed in the following sections categorizing the studies to laboratory-scale studies and actual studies.

#### **2.4.1.1 Laboratory-scale chamber studies**

There are several studies that show a reduction of CO<sub>2</sub> in the presence of indoor plants. However in some studies no CO<sub>2</sub> absorption has been shown with the introduction of the plants to the indoor environment.

Burchett et al. have conducted chamber studies for 'Spath' and 'Pothos'. One species has shown an increase of CO<sub>2</sub> concentration inside and the other one has shown no change of CO<sub>2</sub> inside the chamber. The study has been repeated placing only the pot without the plant shoot. This has shown a higher increase of CO<sub>2</sub> concentration inside the room which concludes that the respiration of the plant and micro-organisms in the soil is greater than the CO<sub>2</sub> absorption by the leaves of the plant (Burchett, Torpy, and Brennan 2009). Thus for a plant system to be an effective CO<sub>2</sub> absorber, the CO<sub>2</sub> consumption from the process of photosynthesis should be at least

greater than the CO<sub>2</sub> generation by the respiration of the micro-organisms and the plant itself. Almost in every study, the plant system (plant and the soil in which the plant is rooted) is considered as a singular unit.

Since micro-organisms in the soils have an unfavourable impact in net CO<sub>2</sub> absorption, studies have been carried out to investigate the “soil-less” plant growth systems. One study has shown that the net CO<sub>2</sub> absorption by the plants grown in hydro-culture is greater than the plants grown in normal potting mix(Irga, Torpy, and Burchett 2013). In the study done by Li et al. emissions from the soil has been neglected since it is considerably low compared to the absorption by the plants(J. Li et al. 2010).

Since these studies have been conducted under varying conditions, it is hard to compare the performance of these plants. The comparison becomes harder with the various units used in measuring the pollutant absorption by plants. A detailed summary of the CO<sub>2</sub> absorption by plants is shown in Table 2-5. In this summary an attempt has been made to quantify the CO<sub>2</sub> absorption under a common unit with the given details and descriptions. The common unit selected for comparison purposes is the weight of CO<sub>2</sub> absorbed per unit area of leaf per unit time ( $\text{mg}\cdot\text{m}^{-2}\cdot\text{s}^{-1}$ ).

However a sound knowledge on factors affecting the indoor CO<sub>2</sub> absorption can be found from these studies. In a few studies the effect of lighting condition has been highlighted. It has been identified that the CO<sub>2</sub> absorption increases with the lighting level up to a certain point and shows a plateau or a decrease afterwards(Burchett, Torpy, and Brennan 2009).In this study it can be seen that the light requirement of the *E. aureum* is about 10 times the *Spathiphyllum*. Fuji et al. have found that the CO<sub>2</sub> absorption increases with the light intensity in the early summer whereas no increase of CO<sub>2</sub> absorption has been observed in the winter season(Fujii et al. 2005).

Temperature also affects the CO<sub>2</sub> absorption by plants. CO<sub>2</sub> absorption has shown a positive trend with the increase of temperature up to 40°C and a negative trend when the temperature has risen above 40°C(Fujii et al. 2005).

In some studies, the effect on existing CO<sub>2</sub> concentration is also highlighted. Oh et al. has done a chamber experiment with hamsters inside and has found that the CO<sub>2</sub> absorption is higher when the rodent respiration is a factor(Oh et al. 2011). In another study (Yarn et al. 2013)it has been found that the absorption increases with the existing CO<sub>2</sub> in the atmosphere. In the study, it has been shown that the most effective way to improve the air quality inside a room is to increase the ventilation rate. However, it has been found that, with the introduction of plants the increase of ventilation rate can be reduced.

Even though generally plant species emit CO<sub>2</sub>at night, it has been found that certain succulent plants absorb CO<sub>2</sub> under no lighting conditions as well. A chamber study done with 6 species of plants shows about 60%-90% reduction in CO<sub>2</sub> concentration(Raza 1995). A detailed description can be found in Table 2-5. A study done using three succulent plants in a hospital environment showed CO<sub>2</sub> absorption during the night time as well. Even though they show a reduction in CO<sub>2</sub> during the night, an increase of concentration has been exhibited during the day(Raza, Shylaja, and Gopal 1995).

However, CO<sub>2</sub> absorption in the day time by C<sub>3</sub> or C<sub>4</sub> plants should be higher than the CO<sub>2</sub> emission in the night to have a positive effect during the day. A study has shown thatCO<sub>2</sub> absorption by the speciesIxora chinensis in the day time is nine times that of the CO<sub>2</sub> absorption at the night (J. Li et al. 2010). In the same study it has been shown that the existing ventilation can dilute the increase of night time CO<sub>2</sub>concentration as the emission is insignificant.

#### 2.4.1.2 Actual studies

Even though the studies done in chambers have shown a net absorption of CO<sub>2</sub>, the projection of these finding to the real environment is complicated. A chamber study has been projected to a real world scenario and it has been found that 57m<sup>2</sup> of *Syngonium podophyllum* plants is required to balance only one occupant's generation(Irga, Torpy, and Burchett 2013).In several studies, indoor walls having small pots of plants has been proposed to be an effective solution(Su and Lin 2013).



A real study has been carried out in a school class room placing one plant for 9.29 m<sup>2</sup>. The plants used in this study were *Dracaena deremensis* (Janet Craig), *Dracaena marginata* (Marginata) and *Spathiphyllum* (Peace lily). The CO<sub>2</sub> concentration inside the school was measured for 3 weeks without plants and 6 weeks with plants. CO<sub>2</sub> level had reduced from 2,004 ppm to 1,121 ppm with the introduction of plants (Pegas et al. 2012). Another study done in an office space having 10-12 m<sup>2</sup> area has shown 10% of reduction in CO<sub>2</sub> in air conditioned space and 25% reduction in naturally ventilated space with the introduction of indoor plants (Tarran, Torpy, and Burchett 2007). A higher reduction in naturally ventilated spaces has been recorded in this study. However, it should be noted that the windows of the naturally ventilated space was closed all the time.

Table 2-5: Quantification of CO<sub>2</sub> absorption by different plant species.

Name	Study prototype [Ventilation rate (°)]	Indoor lighting	Conditions maintained	Quantification		Citation
				Day time absorption	Night time emission	
areca palm	Chamber study [0.3-0.5 ms <sup>-1</sup> ]	1000 LUX	1100 ppm	0.096-0.393 mgm <sup>-2</sup> hr <sup>-1</sup>	-NS-	(Oh et al. 2011)
<i>Chrysalidocarpus lutescens</i>	Chamber study [0.3-0.5 ms <sup>-1</sup> ]	150 – 300 LUX	Hamster respiration	0.153-0.48 mgm <sup>-2</sup> hr <sup>-1</sup>	-NS-	(Su and Lin 2013)
Bird's nest fern <i>Asplenium nidus</i>	Chamber study [6 lh <sup>-1</sup> ]	350-700 lux	2000 ppm	0.0625 mgm <sup>-2</sup> s <sup>-1</sup>	with lights - 0.096 mgm <sup>-2</sup> s <sup>-1</sup> (6)	(Su and Lin 2013)
Weeping fig <i>Ficus benjamina</i>	Chamber study [0.3-0.5 ms <sup>-1</sup> ]	1000 LUX	1100 ppm	0.065-0.174 mgm <sup>-2</sup> hr <sup>-1</sup>	-NS-	(Oh et al. 2011)
		150 – 300 LUX,	Hamster respiration	0.12-0.24 mgm <sup>-2</sup> hr <sup>-1</sup>	-NS-	
Conferta <i>Juniperus conferta parl</i>	Chamber study [Dehumidifier – 50l/min]	30 klx in Summer Winter		145.6 mg/day;	0.249 mgm <sup>-2</sup> s <sup>-1</sup>	(Fujii et al. 2005)
				27.5 mg/day	0.0425 mgm <sup>-2</sup> s <sup>-1</sup>	
Peace lily <i>Spathiphyllum clevelandii</i>	Chamber study [0.3-0.5 ms <sup>-1</sup> ]	1000 LUX	1100 ppm	0.087-0.145 mgm <sup>-2</sup> hr <sup>-1</sup>	-NS-	(Oh et al. 2011)
		150 – 300 LUX,	Hamster respiration	0.109-0.284 mgm <sup>-2</sup> hr <sup>-1</sup>	-NS-	
Arrowhead vine <i>Syngonium podophyllum</i>	Chamber study Hydroculture treatment	10 µmolPAR m <sup>-2</sup> s <sup>-1</sup> 350µmolPAR m <sup>-2</sup> s <sup>-1</sup>	1000 ppm 1000 ppm	27% over 40 mins 61% over 40 mins	-NS- -NS-	(Irga, Torpy, and Burchett 2013)
<i>Verbena bipinnatifida</i>	Chamber study	Indoor day light	400 ppm	75.2% for 1 hr	-NS-	(Raza 1995)
Michaelmas Daisy <i>Aster amellus</i>	Chamber study	Indoor day light	400 ppm	5.71% for 1 hr	-NS-	(Raza 1995)
Annual daisy	Chamber study	Indoor day	400 ppm	46.67% for 1 hr	-NS-	(Raza 1995)

<i>Bellis annua</i>		light						
<i>Chrysanthemum indicum</i>	Chamber study	Indoor day light	400 ppm	48.57% for 1 hr	-NS-	(Raza 1995)		
<i>Ixora coccinea</i>	Chamber study	Indoor day light	400 ppm	63.81% for 1 hr	-NS-	(Raza 1995)		
Janet Craig	Real study	Indoor lighting		2004 to 1121 ppm	-NS-	(Pegas et al. 2012)		
<i>Dracaena deremensis</i>	Real study	Indoor lighting		2004 to 1121 ppm	-NS-	(Pegas et al. 2012)		
Marginata								
<i>Dracaena marginata</i>	Real study	Indoor lighting		2004 to 1121 ppm	-NS-	(Pegas et al. 2012)		
Peace lily								
<i>Spathiphyllum clevelandii</i>	Real study	Indoor lighting		2004 to 1121 ppm	-NS-	(Pegas et al. 2012)		
Penwiper								
<i>Kalanchoe marmorata</i>	Chamber study	In dark	400 ppm	-NS-	90.48% for 1 hr <sup>(b)</sup>	(Raza 1995)		
<i>Pepromia pellucida</i>	Chamber study	In dark	400 ppm	-NS-	60% for 1 hr <sup>(b)</sup>	(Raza 1995)		
Many fingers								
<i>Sedum pachyphyllum</i>	Chamber study	In dark	400 ppm	-NS-	61.9% for 1 hr <sup>(b)</sup>	(Raza 1995)		
Aloe type								
<i>Apicra deltoidea</i>	Chamber study	In dark	400 ppm	-NS-	80.95% for 1 hr <sup>(b)</sup>	(Raza 1995)		
Air plant								
<i>Bryophyllum calycinum</i>	Chamber study	In dark	400 ppm	-NS-	61.9% for 1 hr <sup>(b)</sup>	(Raza 1995)		
Air plant								
<i>Bryophyllum pinnata</i>	Chamber study	In dark	400 ppm	-NS-	84.76% for 1 hr <sup>(b)</sup>	(Raza 1995)		

-NS- - Not stated

<sup>(b)</sup> Indicated when available

<sup>(c)</sup> Absorption

#### 2.4.2 Absorption of Volatile Organic Compounds (VOCs)

Considerable attention has been paid to study the absorption of VOC by the plants. Some studies have been carried out to find the effect of plants on Benzene, Toluene, Ethylbenzene, and Xylenes (BTEX) separately because of its' known carcinogenic potential.

VOC absorption by the plants is highly subjected with the plant species used. Several plants have exhibited the VOC emission as well. A study has shown that 40 plants growing in dunes, macchia, garrigue, forest and riverside habitats in Italy, France and Spain emits 32 types of VOC to the atmosphere. Emission of individual compound has varied up to  $20 \mu\text{g}\cdot\text{h}^{-1}$  per one gram of dry leaf ( $\mu\text{g}\cdot\text{g}^{-1}\cdot\text{h}^{-1}$ ) (Owen, Boissard, and Hewitt 2001). The highest emitted VOC compound was identified as isoprene. Another study which has carried out in Finland has shown emission of isoprene up to  $76 \mu\text{g}\cdot\text{g}^{-1}\cdot\text{h}^{-1}$  from species 'Willow' and 'Aspen'. The same study has shown that monoterpene is also emitted in the range of  $2.8\text{-}12 \mu\text{g}\cdot\text{g}^{-1}\cdot\text{h}^{-1}$  from all the tree species studied (Hakola, Rinne, and Laurila 1998). It has to be noted that these species are outdoor species. Thus the emission of VOC can easily get diluted. However, keeping these species indoor is not advisable as these plants can rise up the VOC concentration beyond the threshold value due to lower fresh air recharge.

Moreover, it is believed that plants having flowers emit VOCs based on the fragrance of the plant. Georgieva et al. have found that plants of the species *Gentiana lutea*, *Gentiana punctata* and *Gentiana asclepiadea*, which are having flowers, emit 81 VOC compounds (Georgieva et al. 2005). Thus an emission of VOC has been found in different plant species.

In another study no removal of benzene was shown by 23 species out of 73 species used in the study (Liu et al. 2007). It can be seen that the VOC absorption or emission defers significantly with the plant species. However, there are several plants which have shown absorption of VOCs. In the study done by Liu et al, 13 species have removed between 0.1–9.99%, 17 species have removed 10–20%, 17 species removed 20–40% and 3 species have removed 60–80% of benzene in contaminated air (Liu et al. 2007). A study done by NASA also has shown the



absorption capacity of Benzene and Trichloroethylene (TCE) by several species (Wolverton, Johnson, and Bounds 1989). The list of the plants which can remove VOC can be found in the Table 2-4. The species which has shown the highest absorption rate of TCE, Benzene, and Formaldehydes along with the absorption rates are shown in Table 2-6. The shaded values represent the five highest absorption rate of each VOC compound.

**Table 2-6 : Removal of VOCs by several species (Wolverton, Johnson, and Bounds 1989)**

Plant species	Removal rate (g.cm <sup>-2</sup> .day <sup>-1</sup> )		
	TCE	Benzene	Formaldehyde
Gerbera daisy	8.5	23.5	-
English ivy	7.3	10.4	9.8
Marginata	3.6	-	2.7
Peace lily	3.4	5.2	1.9
Mother-in-law's tongue	2.7	10	10.9
Pot mum	-	18.2	-
Warneckeii	1.9	5.4	-
Banana	-	-	11.7
Bambo palm	1.6	3.3	5.4
Heart leaf philodendron	-	-	5

Note: TCE - Trichloroethylene

Even though the CO<sub>2</sub> is absorbed by the leaves of the plants, it has been found that the VOCs are absorbed by the micro-organisms in the plant-pot mix (Burchett, Torpy, and Brennan 2009; Irga, Torpy, and Burchett 2013). Burchett et al have found that the VOC absorption by those micro-organisms increases with the increase of exposure time. The removal rates are found to be higher in the high VOC concentrations (Burchett, Torpy, and Brennan 2009). A study done using hydroculture as the plant grown medium, has shown a lesser VOC absorption compared to the normal potting mix (Irga, Torpy, and Burchett 2013). They have concluded that the low potential of hydro-cultured plants was due to the absence of the micro-organisms which consumes the VOC. Moreover it has been found that

these micro-organisms cannot survive for so long without the root system. All these studies have been carried out in laboratory-scale chambers. There are very few studies that have been carried out under actual conditions as well.

#### 2.4.2.1 Actual room studies

It has been found that the combination of plants *Dracaena* and *Spathiphyllum* is capable of removing TVOC from an office environment when the concentration is more than 100 ppb. When the concentration rose above 400 ppb micro-organisms in the plant system, 75% of the VOC content was removed (Tarran, Torpy, and Burchett 2007).

In the study conducted by Pegas et al, described in the Section 2.4.1.2, it has shown a 73% reduction of VOC content from the initial concentration of  $249 \mu\text{g.m}^{-3}$ . It has shown a reduction in BTEX also. From this study it has been found that the removal of benzene in the actual environment is only about 15% whereas the same plants have reported about 78% of removal of benzene in chamber studies. Thus the projection of the chamber studies to real environment is needed to be carefully done considering the scale and the environmental conditions. Moreover it can be concluded that in order to obtain a significant change in VOC concentration, long time measurements should be carried out in real situations (Pegas et al. 2012).

#### 2.4.3 Other air pollutants absorption

There are several studies which reveal the absorption effects of several other pollutants too. A study has found that succulent plants named *Kalanchoe marmorata* and *Crassula* can be used to absorb the  $\text{SO}_2$  from air (Raza and Shylaja 1992). Hill et al suggested that the plant 'Alfalfa' (*Medicago sativa*) has the ability to absorb atmospheric HF,  $\text{SO}_2$ ,  $\text{Cl}_2$ ,  $\text{NO}_3$ ,  $\text{O}_3$ , NO and PAN (Peroxyacetyl Nitrate) (Hill 1971).

#### 2.4.4 Psychological effect

It is well known that the stress induced in people from the work can be reduced by the interactions with the nature. Keeping plants inside of work places can be considered as a means of increasing the involvement with the natural environment. Several studies have been carried out to find the psychological benefits of the plants. A review study (Bringslimark, Hartig, and Patil 2009) shows that, these studies have



been conducted with mainly office workers, students from high schools, students from universities, and patients using questionnaire survey and medical analysis as the psychological measurement. A solid conclusion cannot be made from these studies since the number of people used in the studies varied from 10s to 100s. The exposure time also varied drastically from a few minutes to about a year. However, several studies subjected in this review have shown increased job satisfaction, reduced mental stress level and eye strains, higher tolerance to pain etc. with the implementation of plants. Another study has shown that indoor plants reduce problems of fatigue, headache, cough, dry throat and dry skin significantly (Fjeld and Bonnevie 2002).

## 2.5 Outdoor micro-climate

Since outdoor environmental quality affects the IEQ, the presence of outdoor air pollutant sources and sinks should be taken into account in designing for better IEQ. These sources and sinks are capable of creating a localized environment which is different from the surrounding climate. Such zones are termed as 'Micro-climates'. Effect of such micro-climates in the indoor environment is a vastly discussed topic as an energy free method to improve IEQ. A considerable number of researches have been carried out under various methods mainly;

- Experimental studies
- Models based on mathematical equations
- Computer simulations

Even though the experimental studies are representing actual conditions, the effect of a single feature on one parameter cannot be separated due to the complexities involved in the real world. Conversely, mathematical models have been developed based on theories and empirical equations in order to study the effect of a single feature. However, the mathematical model will represent the ideal situations which represent a hypothetical scenario far-fetched from reality. Therefore experimental studies and mathematical models alone have failed to provide reasonable explanations to as of how a single feature affects the improvement of environmental quality. However with the recent advance development of computation, numerical



models that are calibrated and verified with experimental data have been used as a reliable research methodology.

The micro-climatic features either increase or decrease the atmospheric temperature. Features which increase the atmospheric temperature can be identified as cement paving, asphalt roads, buildings, towers etc (Weng 2001; X. Yang et al. 2013). Some of these features are avoidable where several features are unavoidable. Thus throughout literature, the main focus has been given to the beneficial effect that vegetation provide as a micro-climatic feature. The effect of vegetation on micro-climate has been identified in two aspects. Those aspects are;

- a. Effect of vegetation on temperature
- b. Effect of vegetation on air quality

### **2.5.1 Effect of vegetation on temperature**

The effect of vegetation on both outdoor and indoor temperature has been studied in literature as far back as to the 1960's. It has been identified that vegetation reduces the temperature by several means. Those processes are,

- Reduce solar gain through windows, doors and openings by shading
- Reduce long wave radiation by lowering temperature of walls due to shading
- Convert sensible heat to latent heat through evapotranspiration

The urban vegetation is in the forms of line vegetation, park area and roof top vegetation. There are several experimental studies that show a reduction of temperature with the presence of these types of vegetation in various countries such as parks in Singapore (Wong and Yu 2005; Yu and Hien 2006), Hong Kong (Giridharan et al. 2008), Japan (Ca, Asaeda, and Abu 1998), Botswana (Jonsson 2004), roof top vegetation in Singapore (Wong et al. 2003), USA (Susca, Gaffin, and Dell'Osso 2011). Several studies show a reduction in peak energy requirement due to the reduction in energy invested for air conditioning due to cooler outdoor atmospheric conditions (Huang et al. 1987).

#### **2.5.1.1 Quantification of the effect of vegetation**

An attempt has been made to quantify and predict the effect of vegetation on temperature in order to use it in future planning and design. A mathematical model

to estimate the temperature reduction due to evapotranspiration has been developed by (Saxena 2002). In this model, the volumetric rate of evapotranspiration is estimated based on the crown area of the tree and moisture dispersion is calculated using a simple Gaussian model. In this model the air is assumed to be adiabatic which is not representing the actual condition. However, temperature reduction due to reduction of insolation has not been taken in to account.

Georgi et al. have tried to quantify the effect of vegetation on thermal comfort level based on the measured solar radiation. They have quantified that solar radiation 'manages to pass through trees' for different types of species using the solar radiation under direct sunlight and shade of the trees. The difference of air temperature and relative humidity under direct sun and shade of the tree have also been measured. In this experimental study a reduction of about 15<sup>0</sup>C has been observed for 80% cut down of direct solar radiation by foliage (Georgi and Zafiriadis 2006). It has to be noted that the temperature reduction due to evapotranspiration has also been included in the observed value since this is an experimental study.

Another reliable analytical model termed as Cluster Thermal Time Constant (CTTC) model has been proposed by (Sharlin and Hoffman 1984). The model has been developed to estimate the air temperature at specific point based on average measo-scale temperature and additional increase of temperature due to short wave and long wave radiation. This model has been modified by (Shashua-Bar and Hoffman 2002) to model the vegetation in urban canopy layer incorporating the solar radiation cut down, evapotranspiration and convective heat loss. This modified model has been identified as "Green CTTC". A study carried out using this model has shown up to 2.5<sup>0</sup>C reduction of temperature can be achieved with the introduction of trees (Shashua-Bar and Hoffman 2004).

Computer simulations were also carried out in quantifying the effect of trees on temperature and the reduction of energy used for cooling. A study has been carried out using a software package called DOE 2.1 to estimate the reduction in energy demand with different levels of vegetation (Huang et al. 1987). They have quantified the reduction of power demand to be 11-25% with the increase of 10% tree canopy

and 30-60% with the increase of 25% tree canopy. In this study only a computer simulation has been carried out. However, the reliability of the DOE 2.1 simulation for outdoor micro-climates is low due to the reasons that have been discussed in the Section 2.5.3. Another study has been carried out using DOE 2.1 followed by an experimental quantification of energy reduction due to vegetation provided. The experimental study shows a 27% and 42% of energy reduction in two houses.

Studies based on computational fluid dynamics (CFD) have become popular since the complexities of the outdoor environment can be simulated using CFD techniques. It can be seen that CFD models which calibrated and verified using experimental data provide reliable quantification of the effect of vegetation on temperature (Mochida et al. 1997). A CFD study which has modelled 0.2 km<sup>2</sup> of vegetation area has shown the temperature reduction of 1.3°C. Moreover it has shown that the effect of this vegetative area extends up to 100 m vertically (Rijal et al. 2010).

Several studies were lately carried out with the outdoor micro-climate analysis software package called “ENVI-met” which is based on CFD. The ENVI-met has been used to come up with different planning and design strategies in terms of outdoor vegetation and thermal comfort. (Spangenberg et al. 2008) have identified that the atmospheric air temperature can be reduced by 2°C and surface temperature can be reduced by 12°C with the introduction of vegetation having leaf area index (described in Section 0) of 5. In the same study they have identified that a larger vegetative area such as parks can be more effective than individual or line vegetation in urban environment.

A simulation carried out in Hong Kong has shown maximum reduction of 1°C at pedestrian level due to 56% of tree cover (Ng et al. 2012). Another model result from a study carried out in Biskra shows an increase of 6°C in temperature with no vegetation compared to the actual situation where the vegetation is present (Boukhabl and Alkam 2012).

In some simulations both ENVI-met and DOE 2.1 have been used. Such study has modelled the effect of 15 m *Ficus Elastica* and 20 m *Yellow Poinciana* on outdoor temperature and indoor thermal comfort levels. The 15 m *Ficus Elastica* has shown a

better performance in both outdoor temperature and indoor thermal comfort as the tree's foliage is capable of intercepting more solar radiation than the other tree types (Fahmy, Sharples, and Eltrapolsi 2009).

Conversely, a simulation carried out in Germany has shown that even though trees can improve the thermal comfort in street canyons, the PM<sub>10</sub> concentration can be higher since the air flow is blocked by the vegetation (Jesionek and Bruse 2003). Thus the effect of vegetation on air quality parameter should also be investigated.

### **2.5.2 Effect of vegetation on air quality**

It is a well-known fact that vegetation utilizes CO<sub>2</sub> for photosynthesis. Thus the urban vegetation should possess the CO<sub>2</sub> removal capacity from the atmosphere. Several research studies records lower CO<sub>2</sub> concentration with the presence of the vegetation in urban environment (Gratani and Varone 2007a). The urban vegetation is in the form line vegetation along the street line, park area and roof top vegetation. An experimental study shows a difference of 12.9 mg/m<sup>3</sup> in CO<sub>2</sub> concentration in between a vegetated area on a roof top and area and non-vegetated area (J. Li et al. 2010).

Vegetation purifies the urban air not only by absorption but also by deposition. As Beckett et al. indicated the vegetation can act as an effective sink due to the high surface area and roughness provided by leaves (J. Yang, Yu, and Gong 2008). Several attempts have been made to quantify the deposition of these pollutants. A study conducted in Chicago in order to find the air pollutant removal by roof top vegetation has shown removal of 1675 kg of air pollutants by 19.8 ha of green roofs in one year with O<sub>3</sub> accounting for 52% of the total, NO<sub>2</sub> (27%), PM<sub>10</sub> (14%), and SO<sub>2</sub> (7%). (J. Yang, Yu, and Gong 2008).

Some simulation studies show that the line of trees along the street can increase the concentration of PMs and EC (Elemental carbon) at the street level. It is suggested that the reason could be the reduced wind speed in the street canyon (Vos et al. 2012). It should be noted that this observation has not validated using field measurements. However, a field study done in Auckland, New Zealand has shown that the NO<sub>x</sub>s tends to be stagnated below the tree canopy level. The results suggest

that the trees reduce the upwards transport of vehicle emissions and fresh air coming downward. Thus planning vegetation in urban environment should be carefully undertaken in order to minimize the adverse effects of the trees.

#### **2.5.2.1 Sri Lankan outdoor micro climate study**

In Sri Lanka several studies have been carried out in order to study the effects of outdoor micro-climates on temperature and air quality levels. A study that has analysed 45 years of data has shown a positive correlation with the increase of atmospheric temperature with the increase of hard cover (Buildings, pavements, roads etc.) throughout that time period (R. Emmanuel 2005). However in this study it has been found that the urban thermal comfort is better than the rural and sub urban thermal comfort. The reason behind this observation can be the shading provided by buildings in the urban areas.

Another study carried out using ENVI-met in order to simulate a street canyon located in Colombo has shown that the reduction of the atmospheric temperature due to the presence of vegetation is insignificant at pedestrian level. However the results have indicated that the better thermal comfort can be achieved using high albedo values in road surface, roofs and the walls (R. Emmanuel, Rosenlund, and Johansson 2007a; R Emmanuel and Fernando 2007).

#### **2.5.3 Numerical simulation of outdoor micro climate**

It is vital now to adopt designing and planning strategies in order to create better outdoor micro-climates. For such a process the suitability of available research methods should be investigated.

It can be understood that only the field measurement can represent the real complexity of the environment (Moonen et al. 2012). However, the effect of single micro-climatic feature cannot be studied in field study. In order to provide guidelines, the micro-climatic features should be subjected to parametric studies separately. Thus the numerical simulation which is verified using field measurements can be used reliably in planning and designing micro-climates.

In numerical simulation, the aspects that should be addressed in order to come up with reliable outcome are as follows,

1. Vegetation – the solar radiation emission and absorption, alteration in wind speed, evapotranspiration, CO<sub>2</sub> absorption, particle adsorption
2. Building materials – Thermal performance, surface roughness affects for dispersion

In previous researches a reasonable attempt has been made to address these aspects with the available knowledge and technology. Table 2-7 shows the comparison of adaptation of the micro-climatic aspects using selected research methodologies.

Among the mathematical models, analytical models, empirical models available the CTTC model which is an analytical model has been used commonly in the previous researches. The CTTC model has been modified to incorporate vegetation and also verified with the in-situ results. Hence this model was selected as a viable outdoor modelling technique.

Among the software available for indoor simulations DOE and DEROB are in high demand since these software can simulate the indoor temperature and energy requirement utilizing the building envelopes and hourly weather input data. Conversely, ENVI-met is a CFD based software package developed in order to simulate the outdoor micro climate which has incorporated large collection of verified models. Both indoor and outdoor can be modelled using software packages a providing platform to write unique CFD codes. FLUENT is one such software which can be used for CFD simulations. Hence, these techniques were selected for a comparison in order to select a research method to provide designing and planning guidelines to create better outdoor micro-climates.

Table 2-7: Comparison of commonly used research methodologies

Micro-climatic aspects	DOE 2.1 and DEROB software packages	CTTC model	ENVI-met Software package	CFD analysis using FLUENT
Solar radiation interaction of vegetation	Horizontal building shade (planer element) with different transmissivity for different densities of tree canopies	Additional increase of temperature due to insolation is added to base temperature	The daily solar radiation profile according to sun path is calculated The radiation cut down by foliage is estimated.	Can be modelled
Turbulence due to vegetation and building	Reduction of wind speed by empirical equation developed by McGinn in 1982 (Huang et al. 1987)	No	RANS turbulence model is used	Can be modelled
Evapotranspiration of vegetation	Incorporating evaporative cooling principles	The effect can be quantified		Can be modelled
CO <sub>2</sub> absorption by vegetation	No	No	A gs model is used	Can be modelled
Other pollutant adsorption and absorption	No	No	PM <sub>10</sub> absorption and adsorption (deposition)	Can be modelled
Thermal performance of building materials	Yes	Yes	Yes	Can be modelled
Surface roughness for pollutant dispersion	No	No	Yes	Can be modelled
Availability	Freely available	Mathematical equations	Freely available	Commercial
Ease of implementation	Evapotranspiration and turbulence effect should be calculated separately	Analytical software such as MATLAB have to be used	The simulation is in one package	All the parameters and models have to be defined from the stretch
Extra capacities	Estimate the indoor thermal comfort and energy demand	-NA-		

Considering the capability and used models in estimating the micro-climatic aspects the ENVI-met was chosen as the all the models are inbuilt, the models have been tested and verified earlier, and the air pollution sources and purification by vegetation of such air pollutants can be modelled. Even though, the CFD modelling by Fluent can be used to simulate all the aspects, it was not chosen considering the availability and easiness of the software.

### 2.5.3.1 Quantifying outdoor micro-climatic features

Quantifying the micro-climatic features has been of great difficulty in these studies. The planer features such as road surface, cement paved areas, grass grown areas can be quantified based on the percentage covered of the horizontal surface. The problem becomes severe in quantifying the vegetation since both vertical distribution and horizontal distribution of vegetation affects the micro-climates. The density of the foliage also affects the temperature and the air pollutant absorption and adsorption.

There are two parameters used to quantify the vegetation. They are,

- Leaf area index (LAI) – The one sided leaf area per one unit in ground
- Lead area density (LAD) – The total one sided leaf area per one unit volume

In ENVI-met software the vegetation should be defined using LAD.

These parameters differ from species to species since the distribution of branches, size and orientation of leaves differs a lot. The methods available for finding these parameters can be divided as direct and indirect methods (Breda 2003). Direct method is to take samples of trees and manually calculate the leaf area. This method is destructive, resource consuming and tedious. Collection of leaves during the period of leaf fall is another direct but non-destructive method which can only be adopted with the deciduous species. Therefore, direct method is the most accurate method.

Indirect methods are mainly based on radiation and image analysis (Law et al. 2001; Meir, Grace, and Miranda 2000). SunScan, AccuPAR, LAI-2000, DEMON are some of the commercially available analysers based on the radiation measurement

(Breda 2003). Analysis of LAI using hemi-spherical photographs (Fish-eye images) have been used in the urban micro-climatic studies as it requires only a camera which can take fish-eye photographs (Neumann, Den Hartog, and Shaw 1989; Spangenberg et al. 2008). Another method using radar is also proposed by several researchers (Sumida et al. 2009; Treuhft 2002). Estimation of LAI and LAD using light detection and ranging (LiDAR) dataset is gaining popularity among all the indirect methods due to its accuracy and easiness (Béland et al. 2011; Garrity et al. 2012; Hosoi and Omasa 2009). However, all these techniques require special instruments which can be difficult to find.

(Lalic and Mihailovic 2004) has proposed an empirical equation to estimate the LAI and LAD based on the tree canopy structure and the maximum LAD for the specific tree. This method has been validated using field measurements and it can be seen that this empirical equation reasonably estimates the LAD profiles of trees. Thus in this study, LAD profile was estimated using the canopy structure measured with total station and empirical relationship suggested by Lalic and Mihailovic. The illustration of the method can be found in Annex C.

## **2.6 Vertical Greening in High-rises**

With the rapid urbanization and population growth more and more high-rises are popping up in the urban city limits. Even though it is suggested to have parks and large vegetated areas to reduce the urban heat island effect and improve the air quality it is becoming impractical due to the scarcity of land. As a solution the concept of vertical greening has been suggested by researchers.

Since this is an emerging field only a few studies can be found under this topic. Several research studies have shown that the vertical greening is highly beneficial in reducing the indoor temperature since vertical greening can reduce the wall surface temperatures drastically. A study done in Singapore has shown about 5°C reduction in wall temperature with the introduction of vertical greening systems (Wong et al. 2010). Another study carried out in laboratory scale has shown a peak reduction of 10°C in the exterior surface (Cheng, Cheung, and Chu 2010). Thus these vertical greening systems will drastically reduce the energy demand as well.

Studies on the effect of vertical greenery on air quality are scarce to find. However, the vertical distribution of air pollutants should be studied in addressing the air pollution in the city through vertical greenery.

### 2.6.1 Vertical profiles of several air quality parameter

The vertical dispersion of air pollutants near the ground level can be complex due to the interaction of emission sources and sinks. Some research studies conclude that the presence of trees can make the air purified in the urban atmosphere (Gratani and Varone 2007b). However some researchers suggest that the presence of trees leads for more stagnation of air pollutants because of tree's resistance to the wind, using computer modelling (J.-F. Li et al. 2013). A simulation done by Li et al in 2013 shows the effect of trees in urban street canyon turns from favourable to adverse when the traffic density is increasing from 0 vehicles/min to 120 vehicles/min. These complexities make the prediction of vertical profile of air pollutant difficult and evoke the necessity of an experimental study to examine the dispersion under local conditions.

Several studies have been carried out to investigate the vertical distribution of air pollutants in the general troposphere (Bischof 1962; Foucher et al. 2011; Seiler and Fishman 1981). A study done in Scandinavian region for CO<sub>2</sub> concentration in the range of 0 km to 3 km from the ground shows different correlations in different seasons of the year (Bischof 1962). Another study done in the range of 8 km to 18 km height above the ground level using satellite data all over the world shows a decrease about 8 ppm in CO<sub>2</sub> concentration in the atmosphere (Foucher et al. 2011). However the studies done in the range of height of a middle-rise building for the vertical dispersion of the air pollutants are comparatively low and it can also be affected by the local conditions.

An experimental study has been carried out in Milano city, Italy around a building with a height of 100m and vertical profiles of PM<sub>10</sub>, CO and mixture of airborne aromatic compounds (TAAC) have been investigated. The experimental results show a steady decrease of about 0.008 mg/m<sup>3</sup> of PM<sub>10</sub> concentration within the 80 m from the ground level whereas CO exhibits a decrease of 20% of the concentration

within first 20 m height above the ground level followed by a negligible decrease within the next 80 m. The TAAC concentration reduces by 3 mg benzene equivalent/m<sup>3</sup> within 50 m from ground where it shows an increase within the next 50 m (Rubino et al. 1998).

## CHAPTER 3

### 3 EFFECT OF INDOOR PLANTS ON INDOOR AIR QUALITY

This chapter focuses on improving the air quality inside mechanically ventilated buildings using indoor plants. Being a highly debatable aspect, attention has been paid to identify the factors affecting the performance of indoor plants considering the Sri Lankan context.

#### 3.1 General

Among the measures that have been taken to purify the indoor air, significant attention has been drawn to the use of indoor plants since it can be identified as the most cost effective method. A significant amount of studies, including a study done by NASA to find out the capacity of indoor plants to purify air has shown a removal of air pollutants by several indoor plants. If the plants are capable of purifying the indoor environment in air conditioned spaces, the fresh air supply can be reduced resulting in a reduction in energy cost. When the amount of purification due to indoor plants can be quantified fresh air supply can be adjusted accordingly.

Large collection of literature suggests that there is a favourable effect of indoor plants on indoor environmental quality. No guidelines as such have been proposed to quantify the effect of indoor plants and to place plants in the indoor environment. The studies discussed under this chapter identify the influential factors to propose a framework for such guidelines.

Past studies have shown that the removal of CO<sub>2</sub> from the indoor environment is more effective than the removal of other pollutants. Moreover, the occupant generated CO<sub>2</sub> is a major problem in mechanically ventilated buildings. Thus the quantification of plants required was carried out based on the CO<sub>2</sub> absorption by the plants.

Since previous studies show a higher CO<sub>2</sub> reduction capacity in actual environment than that in studies done in laboratories, consideration has been paid to study the actual situation. An attention has been paid to the practicality of implementing the



research finding for real life conditions. The study was extended to find out the effect of plants on VOC concentration as well.

### 3.2 CO<sub>2</sub> Absorption by indoor Plants

Photosynthesis is a natural process which utilizes the CO<sub>2</sub>, H<sub>2</sub>O and solar energy to produce carbohydrates as given in Equation 3-1.

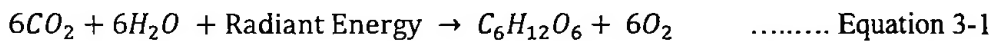

Other than photosynthesis, photorespiration (Respiration of plants) and respiration of micro-organisms in the soil also affect the CO<sub>2</sub> balance between plant system and surrounding environment as shown in Figure 3.1. The net absorption of CO<sub>2</sub> by indoor plants should be considered as the effective CO<sub>2</sub> absorption in a mechanically ventilated room.



The net CO<sub>2</sub> absorption (*A*) can be expressed as;

$$A = P_p - (R_p + R_m) + A_o \quad \dots \text{Equation 3-2}$$

Where,

- $P_p =$  CO<sub>2</sub> absorption by photosynthesis
- $R_p =$  CO<sub>2</sub> emission by photorespiration
- $R_m =$  CO<sub>2</sub> emission by micro-organism in soil
- $A_o =$  Other absorptions by the environment such as walls partition ceiling etc.

Note: *A<sub>o</sub>* has been assumed to be constant throughout the study

Figure 3.1: CO<sub>2</sub> balance between plant system and surrounding environment

#### 3.2.1 Simulation of CO<sub>2</sub> concentration inside a mechanically ventilated room

The CO<sub>2</sub> concentration inside an occupied room gradually increases. The increase of the CO<sub>2</sub> concentration may be due to several factors including generation of CO<sub>2</sub> by human respiration. However, if ventilation is provided, the indoor CO<sub>2</sub> concentration can be controlled to be maintained at an acceptable level. When the

generation of CO<sub>2</sub> takes place in a mechanically ventilated room, the relationship shown in Equation 3-3 can be conceived to model and simulate the CO<sub>2</sub> accumulation (Persily 1994). An illustration of the latter is shown in Figure 3.2.

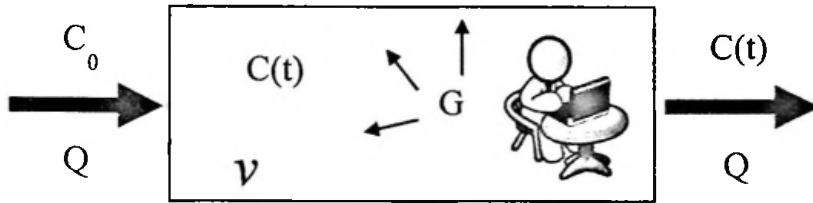

Figure 3.2: Mass balance of CO<sub>2</sub> inside a mechanically ventilated room

$$v \frac{dc}{dt} = Q[C_0 - C(t)] + G \dots\dots\dots \text{Equation 3-3 (Persily 1994)}$$

Where,

- v = Space volume,
- C(t) = Indoor CO<sub>2</sub> concentration at time t,
- Q = Volumetric airflow rate into (and out of) the space,
- C<sub>0</sub> = Outdoor CO<sub>2</sub> concentration and
- G = Generation rate of CO<sub>2</sub> in the space at time t

When plants are introduced to the same room, the relationship shown in Equation 3-4 can be utilized for simulation purposes. An illustration is given in Figure 3.3.

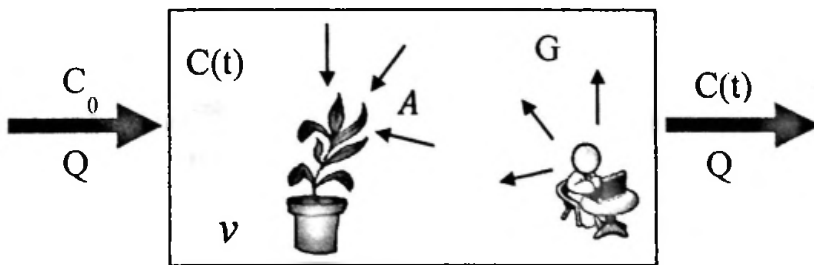

Figure 3.3: Mass balance of CO<sub>2</sub> inside a mechanically ventilated room with indoor plants

$$v \frac{dc}{dt} = Q[C_0 - C(t)] + G - A \dots\dots\dots \text{Equation 3-4}$$

Where,

- $v$  = Space volume,
- $C(t)$  = Indoor CO<sub>2</sub> concentration at time t,
- $Q$  = Volumetric airflow rate into (and out of) the space,
- $C_0$  = Outdoor CO<sub>2</sub> concentration and
- $G$  = Generation rate of CO<sub>2</sub> in the space at time t
- $A$  = Net absorption rate from Equation 3-2

The net absorption by indoor plants can be expressed as;

$$A = \alpha S$$

Where,

- $\alpha$  = Absorption rate per leaf area
- $S$  = Total leaf area

A comprehensive database of  $\alpha$  under possible indoor conditions (i.e. different lighting conditions, inside CO<sub>2</sub> concentrations, arrangement of plant etc.) should be created to quantify the amount of leaf area required for a specific space. In creation of such a database, theoretical developments and gathering of empirical data should be carried out under a common framework. Thus a series of experiments were carried out to come up with such framework criteria.

### 3.3 The Framework Criteria for Experiments on Absorption rates

The CO<sub>2</sub> absorption rate mainly depends on photosynthesis. Therefore the factors affecting photosynthesis influence the CO<sub>2</sub> absorption as well. The main factor that affects the photosynthesis is the species. Different species have different levels of chlorophylls, which are responsible for producing carbohydrates, in leaves.

In this study the main consideration has been paid to environmental factors that affect the CO<sub>2</sub> absorption. The environmental factors directly affecting photosynthesis can be listed as;

1. Atmospheric temperature and relative humidity
2. Soil moisture content
3. CO<sub>2</sub> concentration
4. Photosynthetically active radiation (PAR)

The framework criteria which have been stated subsequently are based on these factors.

### **3.3.1 Indoor temperature and relative humidity**

It has been found that CO<sub>2</sub> assimilation rate increases to an optimum point and decreases afterwards with the increase of temperature (Jolliffe and Tregunna 1968). Hence experiments for indoor plants should be carried out at a constant temperature. The design temperature for mechanically ventilated spaces is 25°C and the relative humidity is between 50 – 60%. Therefore, experiments must be carried out under these conditions for practicality.

### **3.3.2 Moisture condition of the soil**

It was identified that water stress reduces the rate of photosynthesis. Hence it is advisable that the plant should not be subjected to water stress. Plants were watered and kept to drain the excess water out before the experiments were carried out.

### **3.3.3 Indoor lighting source and lighting level**

In photosynthesis, the energy required for the process is gained by the photosynthetically active radiation which is having a wavelength range from 400 nm to 700 nm. It is the same wavelength range of visible light. The relative photosynthetic action and the relative sensitivity of the human eye for radiation in this range are given in the Figure 3.4.

However the spectrum emitted by various lighting sources is different as shown in Figure 3.5. Thus the amount of radiation from different light source can be different even though they appear to be same in brightness which is measured in photometric units (i.e. LUX, Foot candle (fc)). Hence measuring the radiation intensity in photometric units should be avoided (Jones 1992). In retrospect, a unit called

photosynthetically active radiation (PAR) has been used, in which the total number of photon received is calculated.

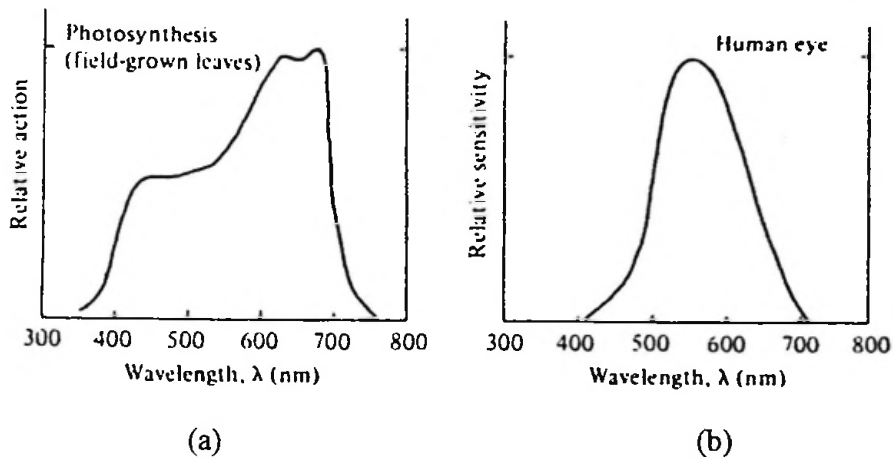

Figure 3.4: Relative action of photosynthesis in the wave range of PAR (a) and relative sensitivity of human eye in wave range of PAR (b) (Jones 1992)

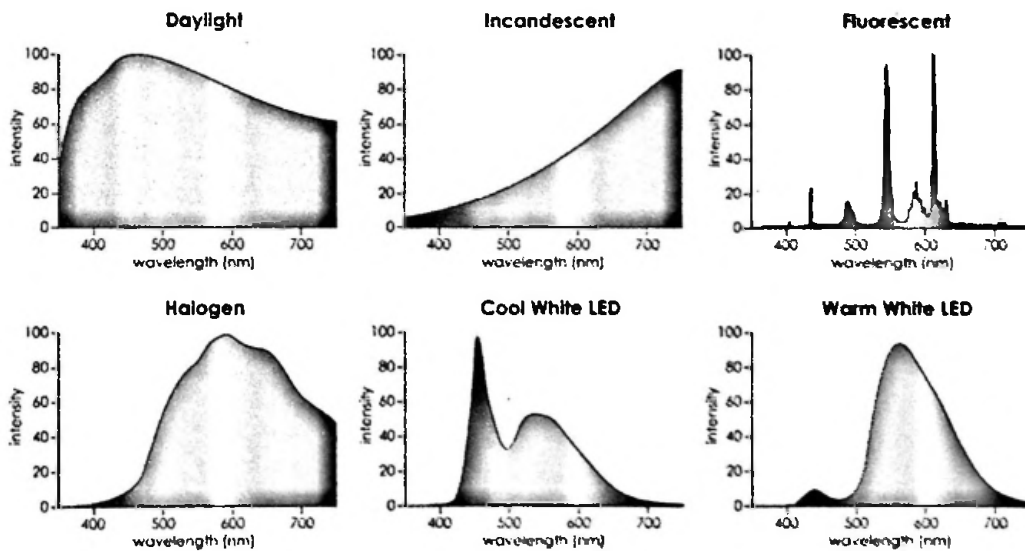

Figure 3.5: Spectral intensity distribution of different light sources (Source: <http://www.lamptech.co.uk>)

However, measuring the photon flux density ( $\text{mol.m}^{-2}.\text{s}^{-1}$ ) can be impractical for building planners. Creation of absorption rates under varying lighting combinations with different intensities would be user friendly in building planning. The experiments in this chapter were carried out under sunlight combined with fluorescent light.

The plants are divided into two categories based on their adaptability for lighting levels. Those categories are;

1. Shade plants – Adopted to low lighting condition
2. Sun plants – Adopted to high lighting condition

The variation of  $\text{CO}_2$  absorption of these two types of plants with the increase of light is given in Figure 3.6. This variation is based on an experiment carried out with 5 shade plants and 8 sun plants (Bohning and Burnside 1956). It can be seen that the  $\text{CO}_2$  absorption increases with the light intensity and reaches to a saturation point. The saturation point of the shade plant is about one fourth of the saturation point of the sun plant which is about 1,000 fc (10,764 LUX). The light source used in this experiment is a reflector flood lamp which is unmentioned of type. However, considering the time period of the research it can be concluded that it should be an incandescent type or halogen type. Thus the saturation intensity under different lighting sources (i.e. sun light, LED etc.) will be different from 1,000 fc.

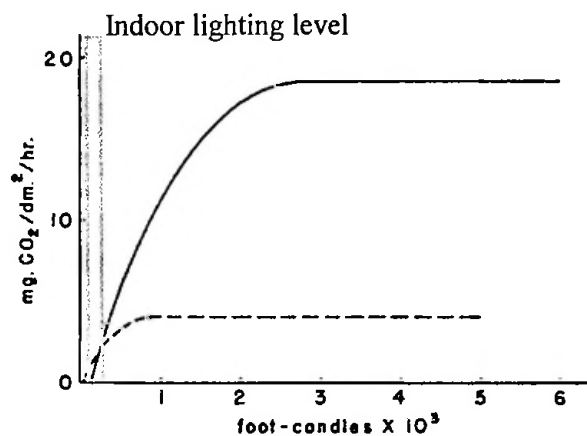

Figure 3.6: Representative curves of apparent photosynthesis on sun (solid line) and shade (broken line) species. (Bohning and Burnside 1956)

However, the minimum saturation intensity for any light source is 5,000 LUX (Jones 1992). The indoor light intensities vary from 300-1,500 LUX which is less than the saturation intensity of a shade plant. The range of indoor light level is also indicated in the Figure 3.6. Therefore, the corresponding lighting condition of the experiment for the particular absorption rate should be stated.

### 3.3.4 Orientation of windows

According to Figure 3.6, plants exhibit higher CO<sub>2</sub> absorption capacity with increase of sun light. Hence keeping plants in front of a window is highly beneficial. Figure 3.7 shows the solar radiation received by plants, considering the sun path over Sri Lanka (Annex A), if kept in front of the window in different orientations. It can be seen that the solar radiation received by the plant is different for those orientations. Thus the CO<sub>2</sub> absorption rate should be derived under the following cases.

- Case 1 - Windows in N/S face
- Case 2 - Windows in E/W face
- Case 3 - Windows in two adjacent faces
- Case 4 - Windows in three faces
- Case 5 - Windows in all four faces

Even though, placing the window to obtain maximum sunlight is beneficial for CO<sub>2</sub> absorption, it can conversely affect the thermal comfort. It also can increase the glare

inside the room which will create an uncomfortable view for occupants. The effect on thermal comfort can be reduced to a considerable extent having double glazing glass in windows. Thus a detailed analysis should be carried out to quantify the beneficial and adverse effects of different orientations of windows.

The experiments conducted on other criteria were carried out under the case 2 placing the plants in front of the window facing east.

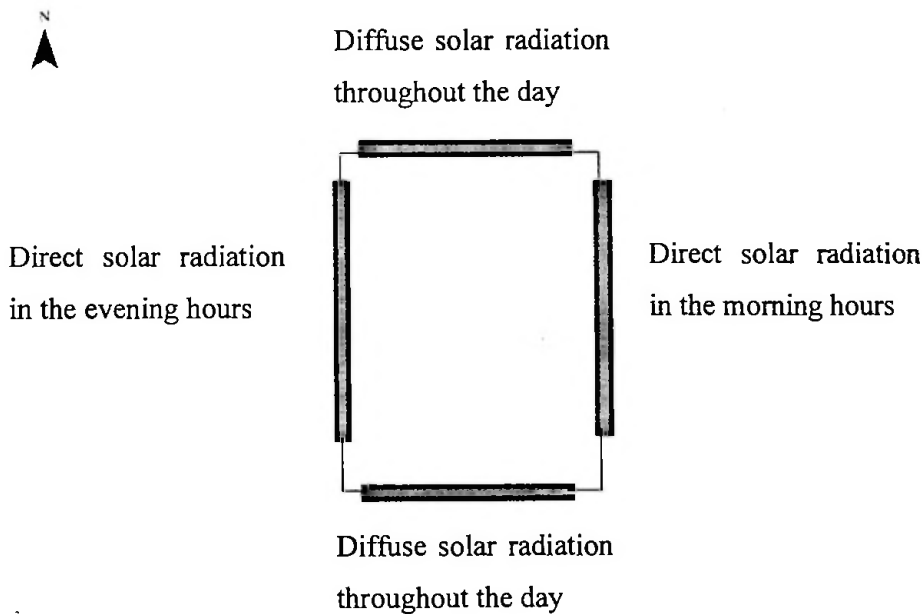

**Figure 3.7:** Solar radiation received through the windows facing different directions

### 3.3.5 Leaf area density

The total assimilation of  $\text{CO}_2$  must increase with the increase of leaf area. However, the increase of the  $\text{CO}_2$  assimilation can be reduced as some plant leaves get shaded by other leaves. This phenomenon occurs only when the leaf area in one particular area is increasing as illustrated in Figure 3.8.

Under the light combination of sunlight and fluorescent light, the highest level of PAR is received from the sunlight. Hence the amount of leaf area should be specified with respect to the length of window (leaf area/unit window length) rather

than specifying leaf area density with respect to floor area or volume of the room. An illustration can be found in Figure 3.9.

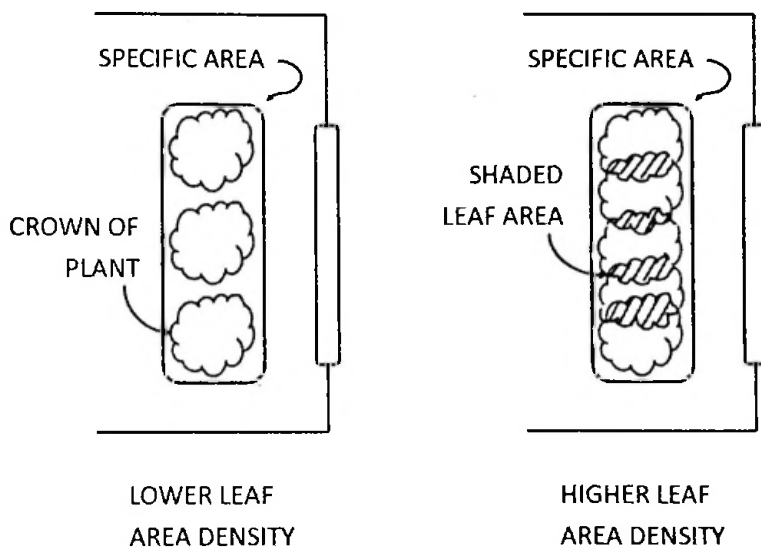

**Figure 3.8:** Shading of leaves with the increase of leaf area density

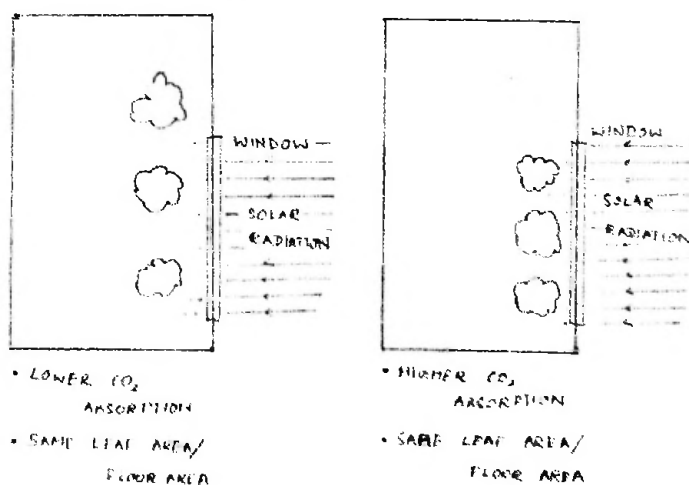

**Figure 3.9:** Non applicability of leaf area/floor area in plant studies

In order to study the effect of increasing leaf density on total CO<sub>2</sub> assimilation, an experiment was carried out using two species of plants in two different locations. The two plant species used in the study are *PleomeleThalioides* (Pleomele) and *Livistonarotundifolia* (Table palm) which are shown in the Figure 3.10.

### 3.3.5.1 Experimental plant

*PleomeleThalioide* (Pleomele) and *Livistonarotundifolia* (Table palm) are shade loving dark green leaved plants which are used as common indoor plants in Sri Lanka. Both of these plants have the ability to survive under water stress and low maintenance requirement. The height of the Pleomele plants used in the experiment is in the range of 0.75-1.5 m and the diameter of a pot is about 300 – 400 mm. The height of the Table palm is in the range of 0.5-0.75 m and the diameter of a pot is about 200 mm.

A relationship between leaf area and the length of a leaf was established for Pleomele plant using 30 leaves. The total leaf area of the Pleomele plant was calculated measuring the length of a leaf and using the relationship obtained since there is a high density of leaves in the Pleomele plant. The leaf area of Table palm was calculated using the digital photographs of each leaf since the number of leaves per plant is in the range of 5 – 7.

### 3.3.5.2 Experimental procedure

The experiments for two types of plants were carried out in two different locations under two different methodologies. Experiments for Pleomele plant (Experiment 1) and Table palm (Experiment 2) were carried out in the test room 1 and test room 2 shown in Figure 3.11 and Figure 3.12 respectively. Description of the test rooms has been shown in the Table 3-1. In both experiments base case measurements of CO<sub>2</sub> concentration, temperature and relative humidity were obtained without keeping the indoor plants. Then the variation of CO<sub>2</sub> concentration was measured by increasing the number of plants inside. Three replicates were carried out for the base case measurement and two replicates were carried out for each incremental step.

The experiment 1 was conducted for 2 hours from 10.00 am – 12.00 noon, elevating the CO<sub>2</sub> concentration of the test room up to 1200 ppm prior to each experiment. The experiment 2 was conducted under the existing CO<sub>2</sub> concentration of the test room. The measurements were taken during day time from 9.00am to 3.00pm for two consecutive days.



(a)



(b)

**Figure 3.10:** Plants used in the experiments; Pleomele (a) and Table palm (b)

**Table 3-1:** Description of the test rooms

Criteria	Test room 1	Test room 2
1. Use of the room	Seminar room	Seminar room
2. Dimensions	8.75 m x 6.4 m x 3 m	6.0 m x 3.5 m x 2.75 m
3. Volume	170.62 m <sup>3</sup>	57.75 m <sup>3</sup>
4. Air conditioning type	Split type air conditioner	Split type air conditioner
5. Fresh air supply	No fresh air supply	No fresh air supply
6. Temperature	set to 25 <sup>0</sup> C	set to 25 <sup>0</sup> C
7. Relative Humidity	60±5%	60±5%
8. Light intensity	4.1 – 16.3 μmolm <sup>-2</sup> s <sup>-1</sup>	5.4 – 26.8 μmolm <sup>-2</sup> s <sup>-1</sup>
9. Wall partitions	Heavy wall	Light wall

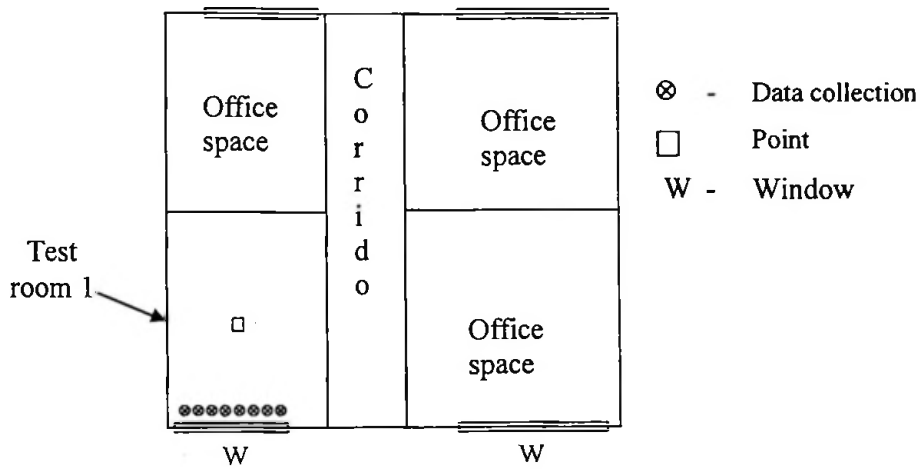

Figure 3.11: The layout of the test room 1

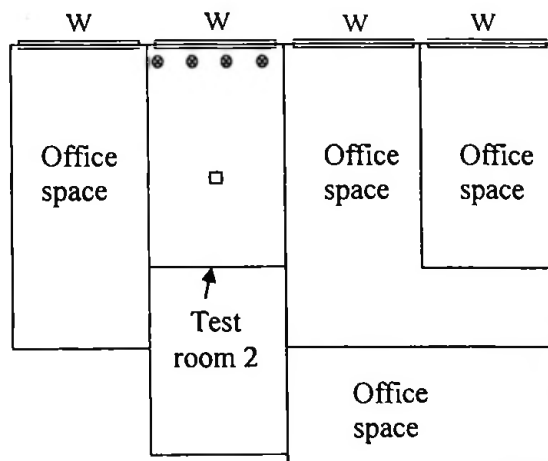
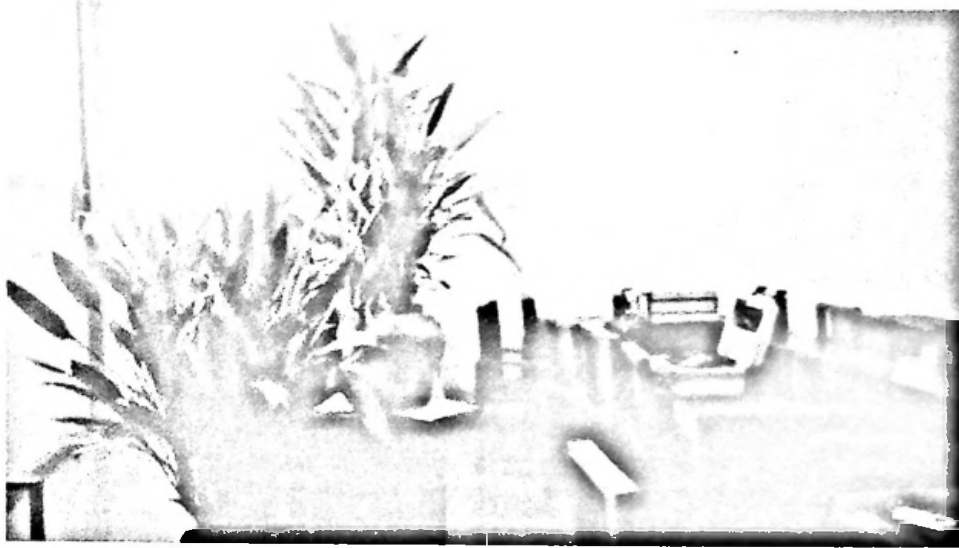

Figure 3.12: The layout of the test room 2

The plants were kept near the window while the instruments were kept in the middle of the room. Figure 3.13 and Figure 3.14 show the arrangement of the plants near the window in the test room 1 and test room 2 respectively. The well-mixed condition was created using a table fan and standing fan.



**Figure 3.13:** Arrangement of Pleomele plants and data collector in the test room 1



**Figure 3.14:** Arrangement of Table palm and data collector in the test room 2

### 3.3.5.3 Experimental results

The results for experiment 1 and experiment 2 are shown in the Figure 3.15 and Figure 3.16 respectively. In order to establish a relationship of leaf area of plants and the indoor CO<sub>2</sub> reduction ( $\Delta\text{CO}_2$ ), the average  $\Delta\text{CO}_2$  was plotted against the area of leaves.  $\Delta\text{CO}_2$  was evaluated based on the Equation 3-5.

$$\Delta\text{CO}_2 = (\text{CO}_2)_b - (\text{CO}_2)_{pn} \quad \dots\dots\dots \text{Equation 3-5}$$

Where,

$(\text{CO}_2)_b$  = Average CO<sub>2</sub> concentration for base case

$(\text{CO}_2)_{pn}$  = Average CO<sub>2</sub> concentration when the plants present

n = Number of plants

Figure 3.17 and Figure 3.18 show the variation of  $\Delta\text{CO}_2$  observed for Pleomele and Table palm with the increase of leaf area. It can be seen a general increase in  $\Delta\text{CO}_2$  with increased leaf area of indoor plants. A sharp gradient can be seen in the Table palm up to the leaf area of 2.5 m<sup>2</sup> and it reduces afterwards. Thus, it is less effective to have higher area of leaf after a particular point, as some leaves are getting shaded by the other leaves.

A sharp increase of CO<sub>2</sub> assimilation was observed in the Pleomele plant up to the leaf area of 10 m<sup>2</sup>. The leaf area was not increased afterwards since the leaf area of 10m<sup>2</sup> amounts to about 20% of the floor area which can be considered as impractical in the real situations.

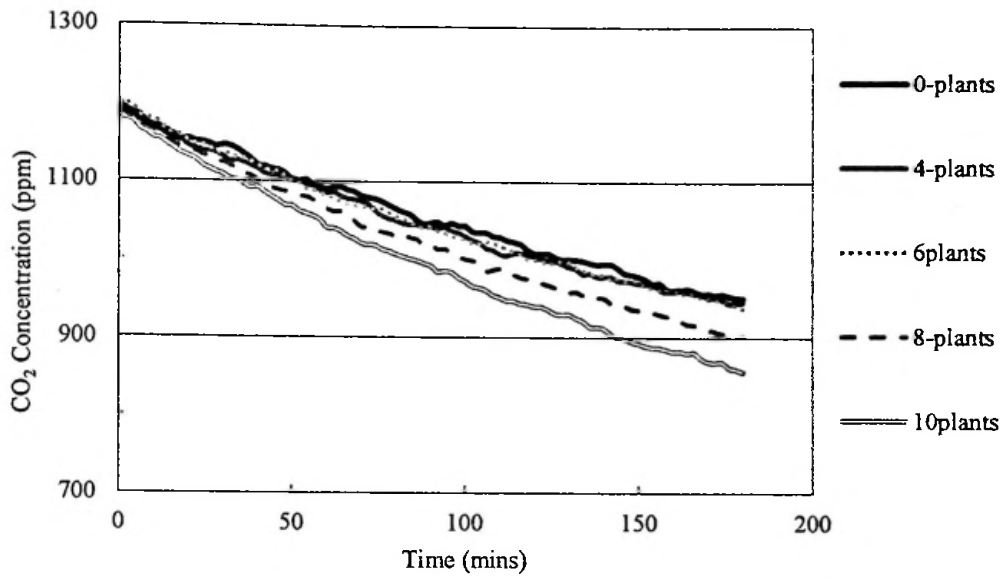

**Figure 3.15:** Variation of CO<sub>2</sub> concentration for 3 hours with the increase of number of plants for Pleomele

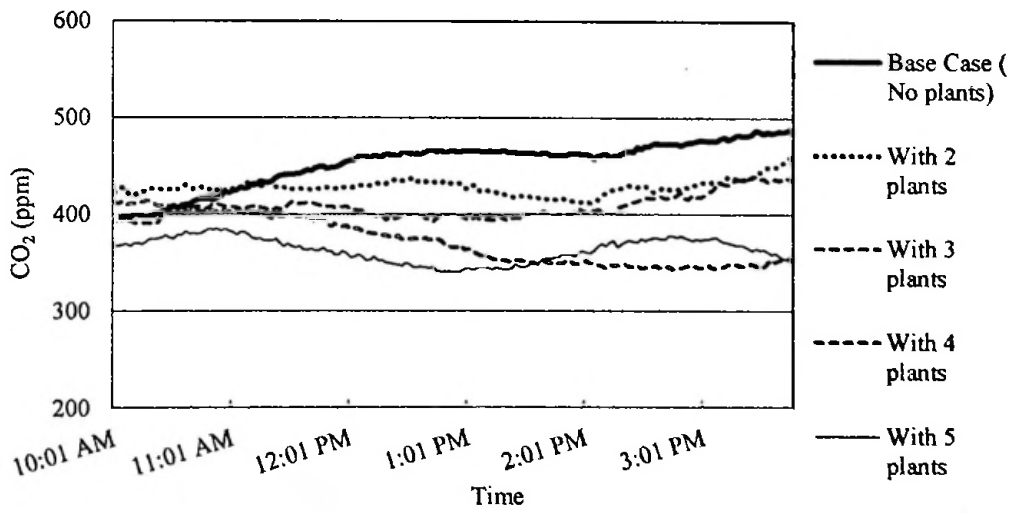

**Figure 3.16 :** Variation of CO<sub>2</sub> concentration for 6 hours with the increase of the number of plants for Table palm

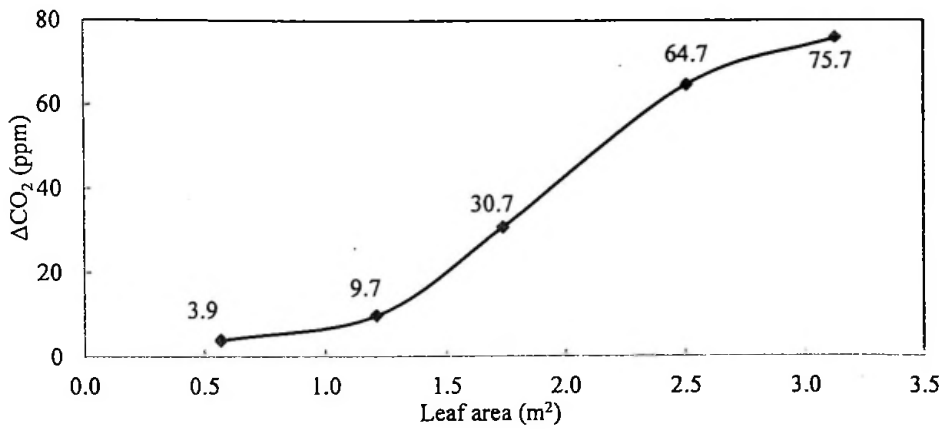

Figure 3.17: Reduction in CO<sub>2</sub> concentration with leaf area for Table palm

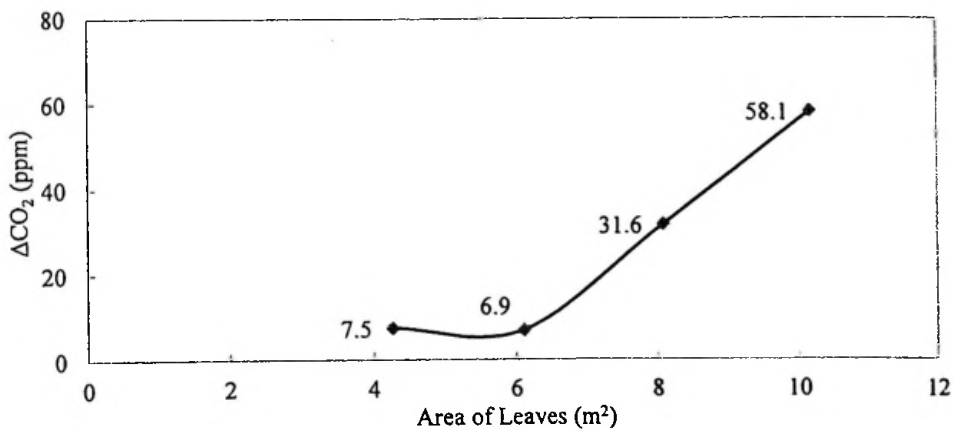

Figure 3.18: Reduction in CO<sub>2</sub> concentration with leaf area for Pleomele

The comparative variation of CO<sub>2</sub> absorption with leaf area density (Leaf area / Length of window) is shown in the Figure 3.19. A higher CO<sub>2</sub> absorption can be seen in the Table palm than that in Pleomele plant. It can be identified that the effective leaf density for Table palm is about 1.6 m<sup>2</sup>/ window length. For the average sized plants (0.5 m – 0.75 m height), this amounts to 3-4 plants per window length of 1 m.

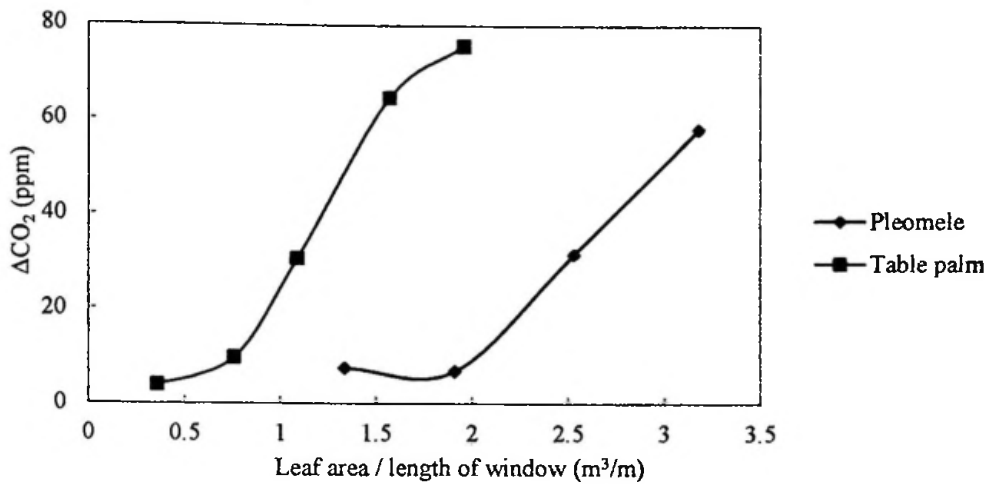

Figure 3.19: Comparative variation of CO<sub>2</sub> absorption of two species

### 3.3.6 Existing CO<sub>2</sub> concentration

It has been found that the rate of photosynthesis varies with the increase of CO<sub>2</sub> as shown in the Figure 3.20 (Jolliffe and Tregunna 1968). The rate of photosynthesis gradually increases with the increase of CO<sub>2</sub> concentration  $C(t)$  up to a saturation point (A). The saturation point can vary with plant species under a given light intensity. Thus, three possible variations of absorption rate ( $\alpha$ ) in the indoor CO<sub>2</sub> concentration range can be derived as shown in Figure 3.21. They are;

- Case 1 -  $\alpha$  is constant with the increase of  $C(t)$
- Case 2 -  $\alpha$  is increasing with the increase of  $C(t)$
- Case 3 - combination of case 1 and case 2

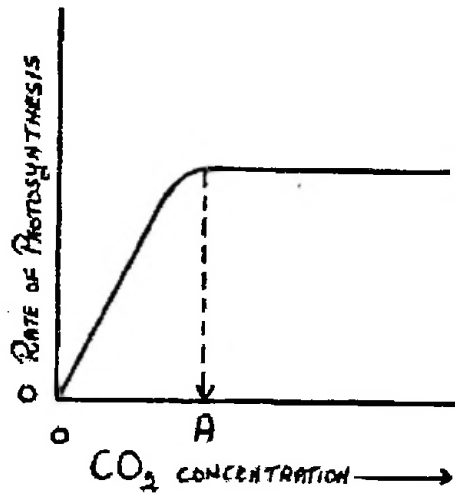

Figure 3.20: Variation of the rate of photosynthesis with the increase of CO<sub>2</sub> concentration (<http://www.skool.ie/skool/homeworkzone.asp?id=233>)

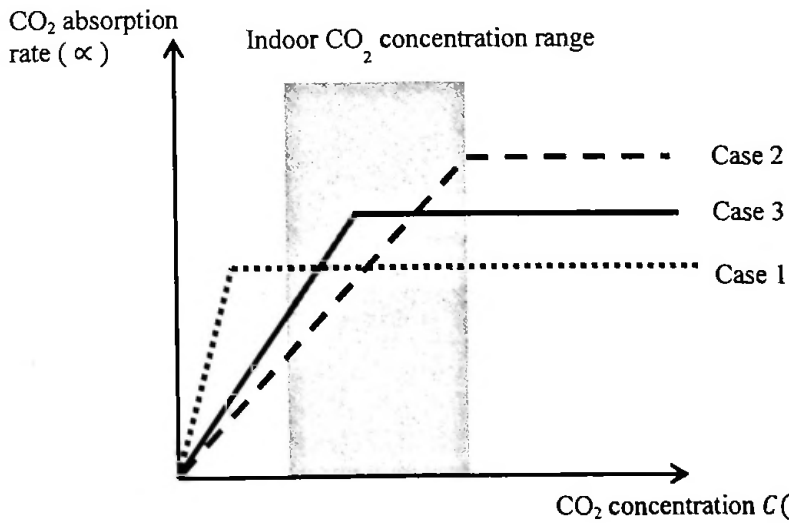

Figure 3.21: Possible variations of absorption rate in the indoor CO<sub>2</sub> concentration range

If  $\alpha$  is constant with the increase of  $C(t)$  the Equation 3-4 can be modified as,

$$v \frac{dc}{dt} = Q[C_0 - C(t)] + G - \alpha S \quad \dots \dots \dots \text{Equation 3-6}$$



Where,

- $V$  = Space volume,
- $C(t)$  = Indoor CO<sub>2</sub> concentration at time  $t$ ,
- $Q$  = Volumetric airflow rate into (and out of) the space,
- $C_0$  = Outdoor CO<sub>2</sub> concentration and
- $G$  = Generation rate of CO<sub>2</sub> in the space at time  $t$
- $S$  = Total leaf area

If  $\alpha$  is linearly increasing with the increase of  $C(t)$ ,  $\alpha$  can be written as  $\alpha(C) = \gamma C(t)$  where  $\gamma$  is a constant. Thus Equation 3-4 can be modified as;

$$v \frac{dc}{dt} = Q[C_0 - C(t)] + G - \gamma SC \dots\dots\dots \text{Equation 3-7}$$

These relationships, derived based on CO<sub>2</sub> mass balance, can be identified as ordinary differential equations. This can be solved for  $C(t)$  using integrating factor method to simulate the indoor CO<sub>2</sub> concentration at a given time. The solved equations for different cases can be found in the Table 3-2. The derivation of these equations can be found in the Annex B.

**Table 3-2:** Equations to simulate indoor CO<sub>2</sub> concentration for different cases

Case	Equation	Number
No plants inside	$C(t) = C_0 + \frac{G}{Q} + \left\{ C(0) - C_0 - \frac{G}{Q} \right\} e^{-t/\tau}$	Equation 3-8
Case 1	$C(t) = C_0 + \frac{G - \alpha S}{Q} + \left\{ C(0) - C_0 - \frac{G - \alpha S}{Q} \right\} e^{-t/\tau}$	Equation 3-9
Case 2	$C(t) = \frac{QC_0 + G}{Q + \gamma S} + \left\{ C(0) - \frac{QC_0 + G}{Q + \gamma S} \right\} e^{-(t + \frac{S\gamma}{V})t}$	Equation 3-10



Where,

$I$  = Air exchange rate per hour,

$C(0)$  = Indoor CO<sub>2</sub> concentration at time  $t=0$

Thus two different equations should be used to simulate the indoor conditions under two cases when there are plants inside. Hence a detailed study was carried out to find the variation of absorption rate with the increase of CO<sub>2</sub> concentration.

### 3.3.6.1 Experimental procedure

The indoor CO<sub>2</sub> concentration was elevated up to different levels of CO<sub>2</sub> concentration in the test room 1 using occupants. The maximum and the minimum elevated CO<sub>2</sub> concentration was 2400 ppm and 1400 ppm respectively where the outdoor concentration was about 400 ppm. Once the indoor CO<sub>2</sub> concentration reaches the desired level, occupants were asked to move out from the room. Subsequently the dispersion of the CO<sub>2</sub> concentration was measured with and without plants inside. In Section 3.3.5, it was identified that the effective leaf area density for Table palm is about 1.6 m<sup>2</sup> per unit length of window. Thus the leaf area of 5.2 m<sup>2</sup> was used in this study as the length of the window is 3.2 m. The same amount of leaf area of Pleomele plant was used in order to compare the performances of two species under the same conditions.

Since the window is facing the East, solar radiation was present during the first half of the day. Thus CO<sub>2</sub> dispersion was measured from 10.00 am to 12.00 noon in two minute interval. The outdoor CO<sub>2</sub> concentration was also measured in 15 minutes interval as it affects the dispersion.

The absorption rates were then calculated as illustrated in Section 3.3.6.2, for different CO<sub>2</sub> levels inside.

### 3.3.6.2 Calculation of the absorption rate

Since the outdoor CO<sub>2</sub> concentration affects the indoor – outdoor air exchange, outdoor CO<sub>2</sub> concentration was subtracted by the indoor CO<sub>2</sub> concentration as suggested by Persily (A. Persily 1997). However, the outdoor CO<sub>2</sub> concentration

variation was not significant as it varied between 395 – 425 ppm. The trend of indoor – outdoor CO<sub>2</sub> concentration with and without plant has shown in Figure 3.22. CO<sub>2</sub> absorption per second per leaf area has been calculated as follows;

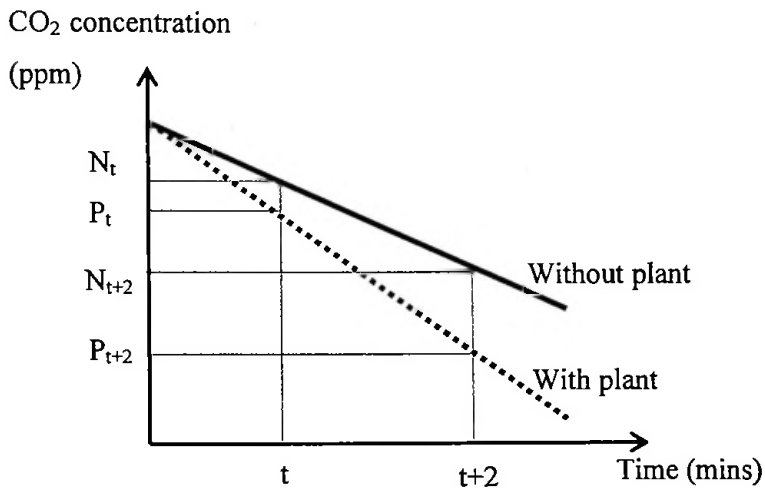

Figure 3.22: Temporal CO<sub>2</sub> concentration variation with and without plant

$$\begin{aligned} \text{CO}_2 \text{ concentration without plants at time } t \text{ (ppm)} &= N_t \\ \text{CO}_2 \text{ concentration without plants at time } t+2 \text{ mins (ppm)} &= N_{t+2} \\ \text{CO}_2 \text{ concentration with plants at time } t \text{ (ppm)} &= P_t \\ \text{CO}_2 \text{ concentration with plants at time } t+2 \text{ mins (ppm)} &= P_{t+2} \\ \text{CO}_2 \text{ loss without plants in 2 min (due to infiltration)} &= N_{t+2} - N_t = \Delta N \\ \text{CO}_2 \text{ loss without plants per unit time (due to air exchange)} &= \frac{dN}{dt} \\ \text{CO}_2 \text{ loss with plants in 2 min (due to air exchange + plant absorption)} &= P_{t+2} - P_t = \Delta P \\ \text{CO}_2 \text{ loss with plants per unit time (due to air exchange + plant absorption)} &= \frac{dP}{dt} \\ \therefore \text{Reduction of concentration of the room in ppm (} 10^{-6} \text{ m}^3/\text{m}^3 \text{) (a)} &= \frac{dP}{dt} - \frac{dN}{dt} \end{aligned}$$

$$\begin{aligned} \text{Weight of 1 mole of CO}_2 &= 44 \text{ g} \\ \text{Volume of 1 mole of CO}_2 \text{ at } 25^\circ\text{C and 1 atm} &= 22.4 \text{ l (} 1000 \text{ l} = 1 \text{ m}^3 \text{)} \end{aligned}$$

$$\text{Reduction of CO}_2 \text{ amount per unit volume (mg/m}^3\text{)} = a \times \frac{44}{22.4}$$

$$\text{Volume of the room} = V \text{ m}^3$$

$$\text{Area of leaves} = L \text{ m}^2$$

$$\text{Total absorption by plants in 2 minutes (mg)} = a \times \frac{44}{22.4} \times V$$

$$\begin{aligned} \text{Absorption rate } (\alpha) \text{ (mg/s/m}^2 \text{ of leaves)} &= a \times \frac{44}{22.4} \times \frac{V}{L} \times \frac{1}{120} \\ &= a \times 0.016 \times \frac{V}{L} \end{aligned}$$

Note:-*This calculation applies only when the variation is linear.*

### 3.3.6.3 Experimental results

Figure 3.23 and Figure 3.24 show the dispersion of CO<sub>2</sub> concentration inside the room with and without plants under different elevated CO<sub>2</sub> concentrations for Pleomele and Table palm respectively. It can be seen that the dispersion is higher when the plants are present inside than without plants due to the absorption of CO<sub>2</sub> by plants.

The calculation of absorption rate in Section 3.3.6.2, gives the average absorption rate for the range in which the CO<sub>2</sub> concentration vary. Considering the variation of CO<sub>2</sub> inside the room, two ranges can be identified for CO<sub>2</sub> variation. These ranges are 2,000-1,500 and 1,500-1,000 named as Range 1 and Range 2 respectively.

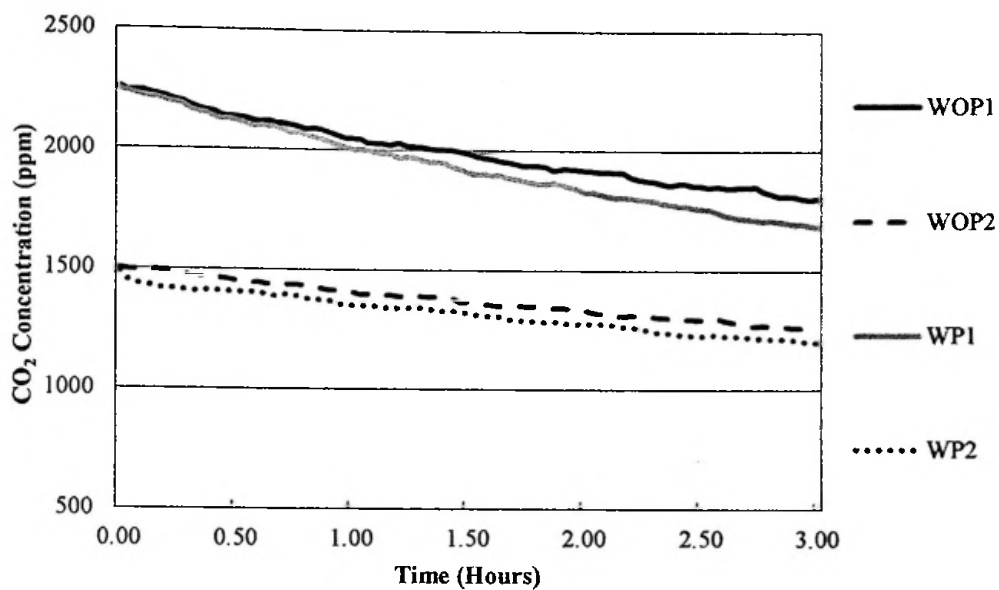

WOP -Without plants                      1 -Range 1 (2,000-1,500)  
 WP -With plants                            2 -Range 2 (1,500-1,000)

**Figure 3.23:** CO<sub>2</sub> variation with time for different concentrations (Pleomele)

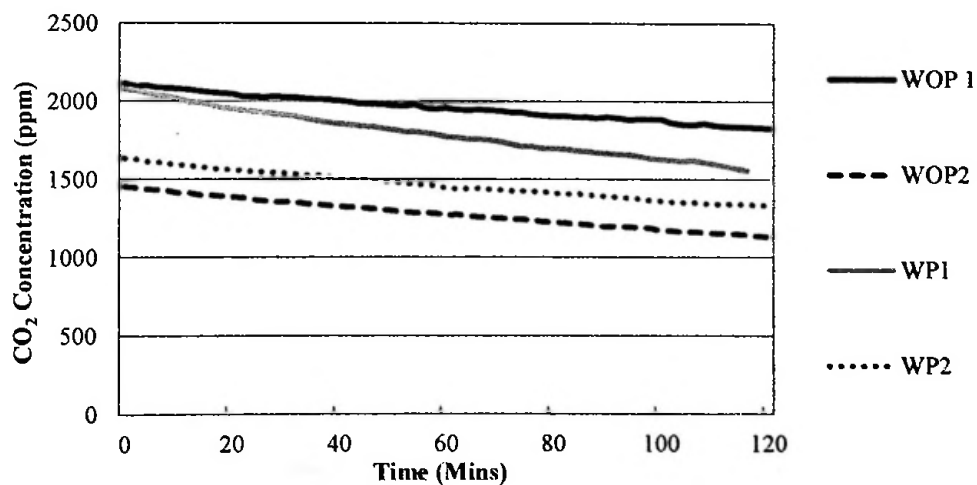

**Figure 3.24:** CO<sub>2</sub> variation with time for different concentrations (Table palm)

In order to estimate the gradient of the dispersion, the linear trend lines given by "Microsoft Excel" were used as shown in Figure 3.25 and Figure 3.26. The

minimum  $R^2$  value observed is 0.9818. This suggests that the variation of the dispersion is well represented by trend lines.

The absorption rate calculated as per the Section 3.3.6.2 is the average absorption rate for the particular  $CO_2$  concentration range. Thus the absorption rates calculated for two different  $CO_2$  concentration ranges have been shown in the Table 3-3.

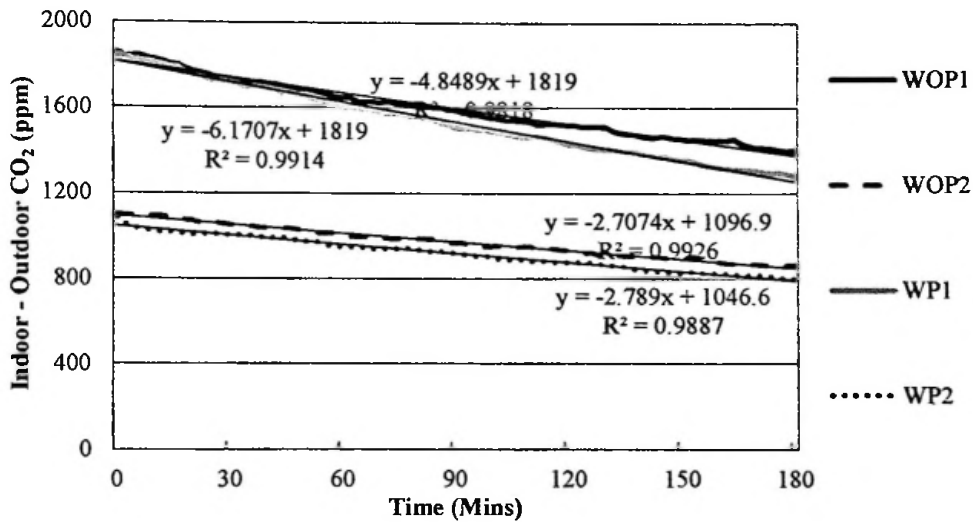

Figure 3.25: The trend lines of the dispersion of  $CO_2$  inside the room (Pleomele)

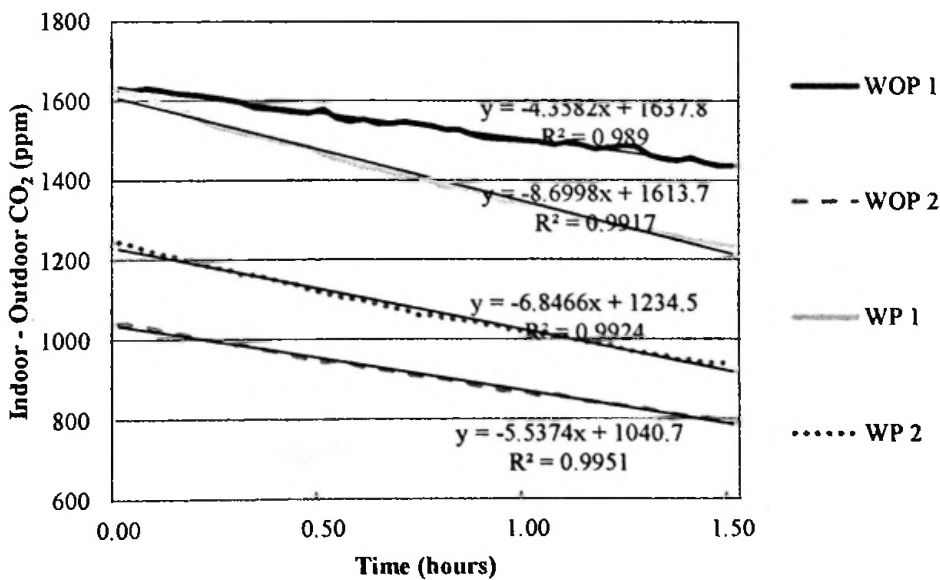

Figure 3.26: The trend lines of the dispersion of  $CO_2$  inside the room (Table palm)

**Table 3-3:** CO<sub>2</sub> absorption rates for two plants for different CO<sub>2</sub> concentration ranges

CO <sub>2</sub> Range	Absorption rate (mg/s/m <sup>2</sup> )	
	Table palm	Pleomele
1000 – 1500 ppm	0.656	0.039
1500 – 2000 ppm	2.178	0.640

#### 3.3.6.4 Verification of the absorption rate

A separate experiment was carried out to verify the CO<sub>2</sub> absorption rate, simulating a real condition. The verification was carried out only for Table palm as it shows considerable CO<sub>2</sub> absorption.

Initially, indoor CO<sub>2</sub> concentration temperature, relative humidity, and wind speed were measured only with occupants for two hours. Then the same parameters were measured with both occupants and plants inside the rooms during the same time period from 10.00 am – 12.00 noon. Four occupants were used in this experiment.

The theoretical CO<sub>2</sub> development of the room without plants was simulated using the Equation 3-8 for different air exchange rates ( $I$ ). The occupant generation rate was used as 0.0051 l/s (A. Persily 1997). The best fit curve was selected in order to estimate the  $I$ , using the least sum of square method. The experimental variation and the theoretical curve is shown in Figure 3.27.

It can be seen that the CO<sub>2</sub> concentration varies from 400ppm to 1000 ppm. Thus it can be assumed that the absorption rate is constant with the increase of indoor CO<sub>2</sub> concentration. Hence, the theoretical CO<sub>2</sub> development of the room with Table palm plants was simulated using the Equation 3-9 for different values for the term( $G - \alpha S$ ). The air exchange rate obtained from Figure 3.27 was used in this calculation. The best fit curve was selected in order to estimate the term( $G - \alpha S$ ), using the least sum of square method. The experimental variation and the theoretical curve are shown in Figure 3.28.

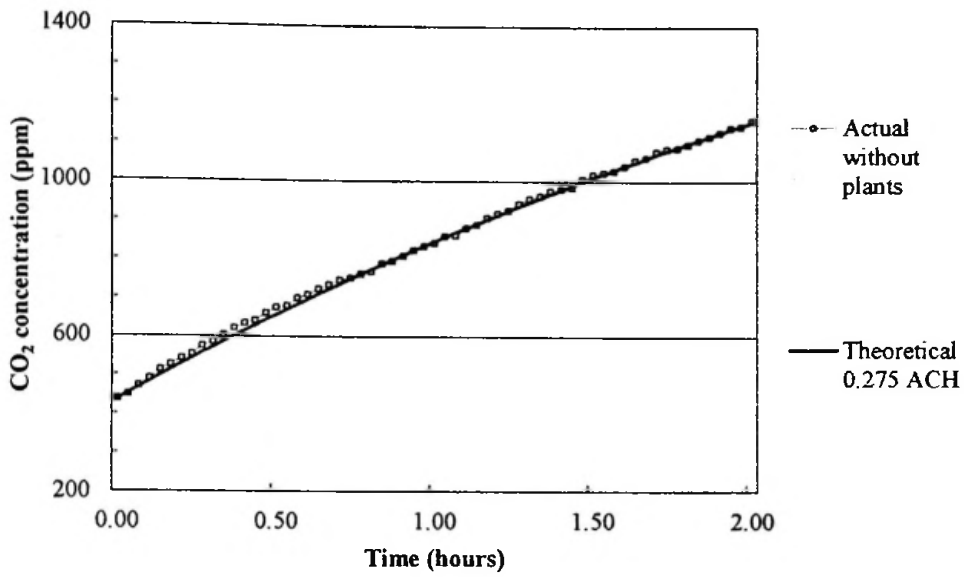

Figure 3.27: Actual and theoretical CO<sub>2</sub> development inside the room due to occupant generation

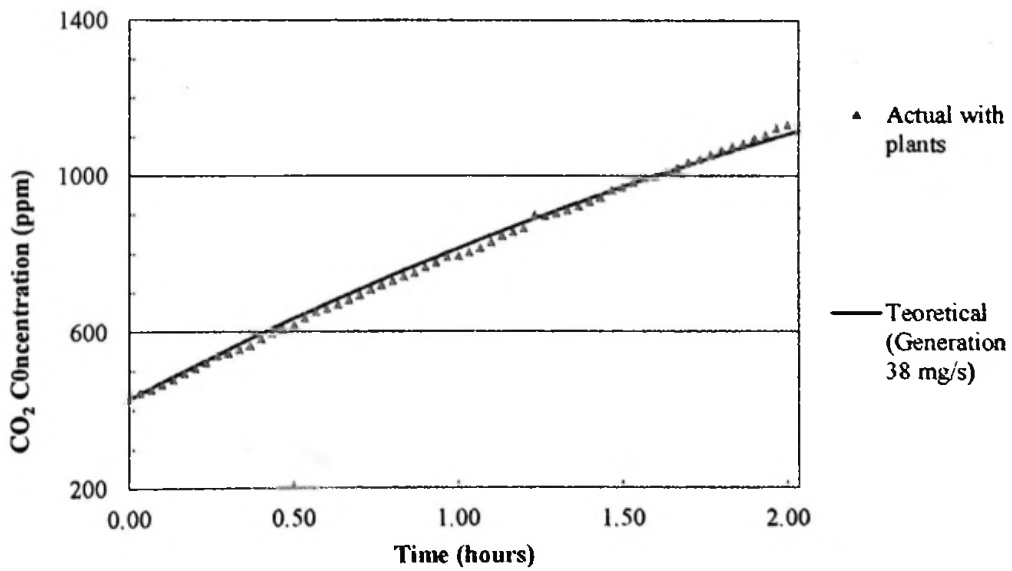

Figure 3.28: Actual and theoretical CO<sub>2</sub> development inside the room due to occupant generation with Table palm inside



From the best fit analysis,

$$G - \alpha S = 38 \text{ mg/s}$$

$$G = 0.0051 \times 4 = 0.0204 \text{ l/s}$$

1 mol of  $\text{CO}_2$  (44g) = 22.4 l

$$G = 0.0204 \times 44 / 22.4 \times 10^3 = 40.8 \text{ mg/s}$$

$$S = 5.2 \text{ m}^2$$

$$\alpha = \frac{40.8 - 38}{5.2} \text{ mg/s/m}^2$$

$$\alpha = 0.538 \text{ mg/s/m}^2$$

This absorption rate is 18% less than the experimental absorption rate for 1,000 – 1,500 range determined in Section 3.3.6.3. It should be noted that the verification was carried out in the range of 400-1,000 ppm. Thus a lesser absorption rate can be anticipated in the verification method. From this observation it can be concluded that the absorption rate obtained under this study is applicable in the real life conditions.

### 3.3.7 Night-time emission

Plants stop photosynthesis during night except for succulent plants (Jones 1992; Raza, Shylaja, and Gopal 1995). According to Equation 3-1, there will be net emission of  $\text{CO}_2$  during the night time due to the dark respiration of plants and the respiration of micro-organisms in the soil. Therefore, the net effect of diurnal  $\text{CO}_2$  absorption can vary. Hence, another study was carried out to quantify the night time emission.

#### 3.3.7.1 Experimental procedure

The  $\text{CO}_2$  concentration of the room was elevated up to  $500 \pm 20$  ppm where the outdoor  $\text{CO}_2$  concentration was  $400 \pm 10$  ppm. Then the dispersion of the  $\text{CO}_2$  concentration inside the room was measured from 7.00 pm to 8.00 am in the following day with and without plants. The  $\text{CO}_2$  concentration was measured in two minute intervals.

### 3.3.7.2 Experimental results

Figure 3.29 shows the variation of indoor CO<sub>2</sub> concentration during night time with and without plants inside. It can be observed that the negative gradient of variation without plants is steeper than that with plants. The reduction of indoor CO<sub>2</sub> concentration has reduced with the introduction of indoor plants due to emission. Absorption rates were then calculated using the gradient of the trend lines suggested by "Microsoft Excel".

The emission rate during the night time for Pleomele and Table palm is 0.019 mg/s/m<sup>2</sup> and 0.040mg/s/m<sup>2</sup> respectively. The emission rate for Pleomele plant is about 50% of the absorption rate for 1500-1000 CO<sub>2</sub> range compared to that of Table palm which is about 6%.

It can be seen that the night time emission rate is lesser than the diurnal absorption rate. Thus the net absorption can be seen per day with introduction of the plant. A considerable reduction in CO<sub>2</sub> concentration can be anticipated in the long run.

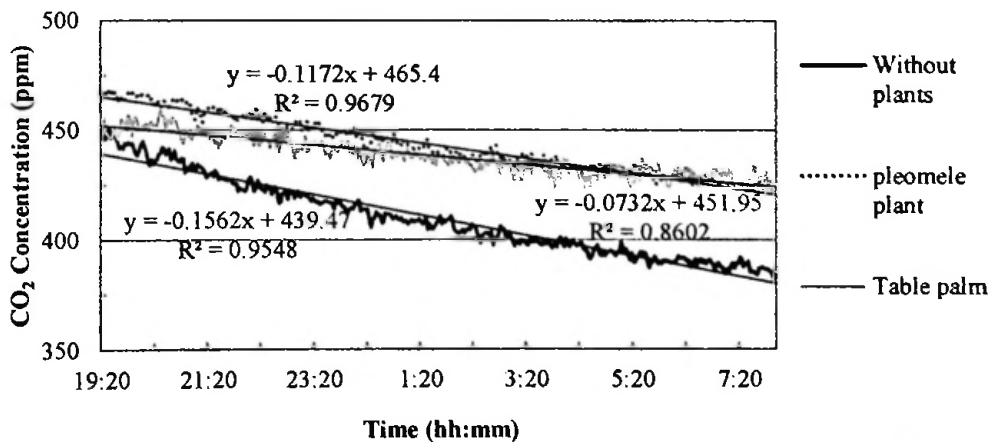

Figure 3.29: Nocturnal variation of CO<sub>2</sub> concentration with and without plants

### **3.4 Effect of indoor plants on VOC concentration**

Since literature suggests that plants are capable of absorption of several other pollutants other than CO<sub>2</sub>, the study was extended to find the effect of plants on VOC concentration.

There is no theoretical evidence that VOC is absorbed by the plant leaf. However, Burchett et al suggest that the micro-organisms in the soil consume VOC in the presence of the root system. Moreover VOC can be adsorbed to plant leaf. Thus two types of mechanisms can be identified in reducing the VOC concentration in a room by the plant system. Namely;

- VOC is adsorbed to plant leaf creating a barrier for VOC dispersion.
- VOC is absorbed by soil-root system acting as a sink source.

Two separate experiments were carried out to study these effects.

#### **3.4.1 Experimental procedure**

Test room 1 was selected for this experiment considering the air tightness of the room. The air exchange was only possible through the door as the room is constructed with heavy walls. Thus the VOC source was created directly opposite the door as shown in Figure 3.30. It can be assumed that the maximum dispersion occurs along the line which connects the source and the center of the door. Hence the data collection point was located 4.5 m away from the source in this line and the plants were kept 1.5 m away around the source point. The arrangement of the room can be found in the Figure 3.31. The temperature of the room was set to 25°C and the relative humidity of the room was 60±5%. The area of the plants used in both experiments is the same area used in the experiment under Section 3.3.6.

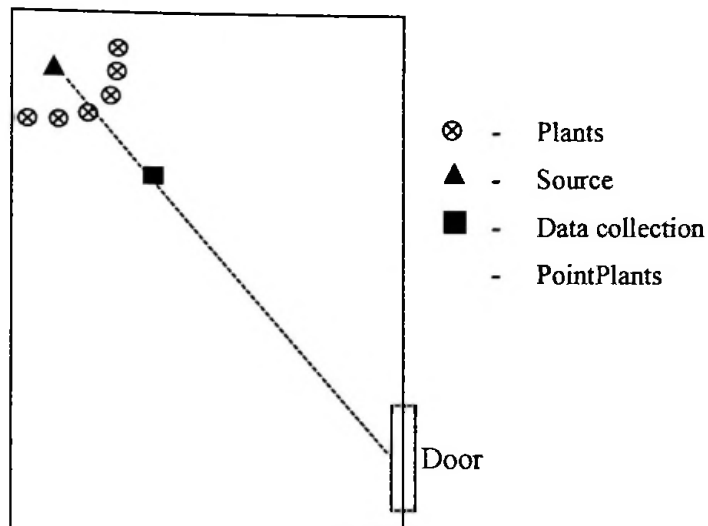

**Figure 3.30:** The arrangement of test room 1



**Figure 3.31:** Arrangement of the Pleomele plant and the data collector in the test room 1

A commonly used furniture polish spray which cleans the furniture was chosen as the VOC source. High concentration of VOC was created in the source location spraying the polish on to a wood plank as shown in Figure 3.32. In order to keep the amount sprayed consistent, one person sprayed the polish for all the experiments. For the experiment carried out to study the barrier effect (Experiment 1) 30 sprays

were used where 50 sprays were used for the experiment carried out to study the absorption effect (Experiment 2).



**Figure 3.32:** Spraying furniture polish to create a VOC source

In the experiment 1, after furniture polish was sprayed, the maximum VOC concentration and time taken to reach the maximum VOC concentration was obtained. The experiment was carried out with and without plant in the room for Pleomele plant and Table palm. In order to study the undisturbed dispersion, no air circulation was provided in the room.

In the experiment 2, the VOC concentration of the room was elevated up to 0.95 ppm using 50 sprays. Subsequently the VOC source was removed and the VOC dispersion was studied with and without plants for about four hours. Only Table palm was selected for this experiment as it has exhibited the highest CO<sub>2</sub> absorption.

#### **3.4.2 Experimental results**

Figure 3.33 shows the results of the experiment carried out in order to study the barrier effect. It can be clearly seen that the peak VOC concentration reduced with the introduction of indoor plants. Moreover, the time taken to reach the maximum also increased. This clearly shows that there is a VOC absorption by indoor plants and plants can be used as a barrier to VOC dispersion. This can be useful in placing stationary VOC sources as photocopiers, printers etc.

Figure 3.34 shows the dispersion of VOC with and without plants in the test room. A clear reduction cannot be seen in the VOC concentration inside the room with the

introduction of plants. The absence of specific micro-organisms which consume VOC can be a possible reason for this observation.

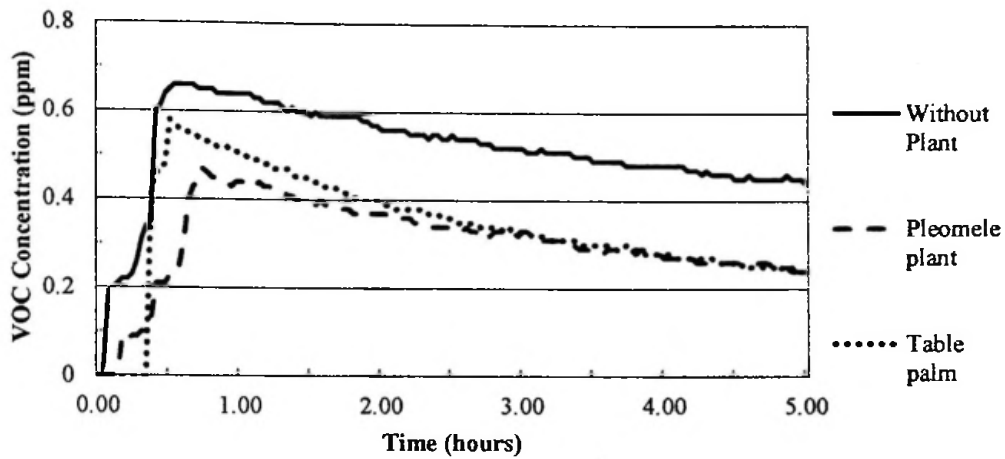

Figure 3.33: Barrier effect on VOC dispersion by indoor plants

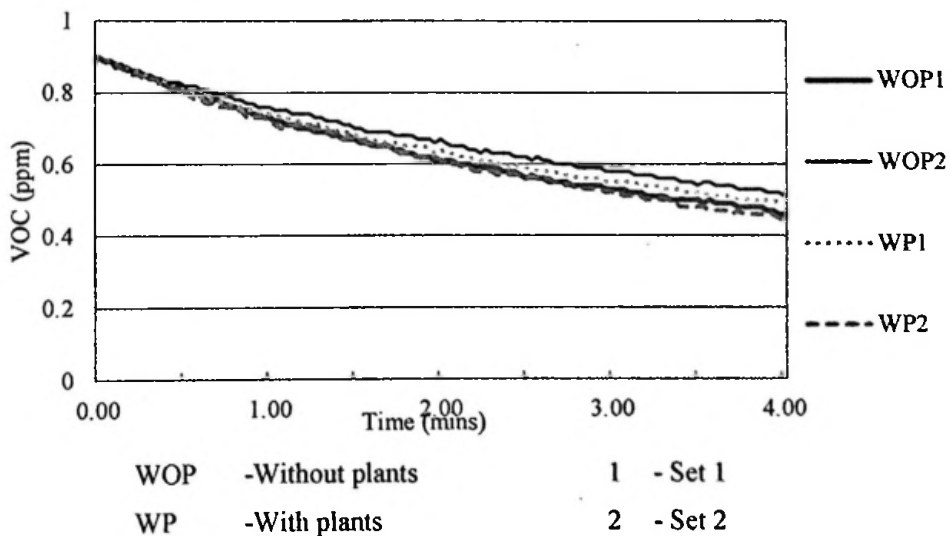

Figure 3.34: VOC dispersion with and without plants for Table palm



### 3.5 Opinion Survey on Indoor Plants

An opinion survey was conducted in order to analyse the acceptance of indoor plants. The study was conducted in three sectors namely, educational sector (students), Health care sector (Doctors, nurses and professionals), and engineering sector (Civil Engineers). 67, 40 and 11 responds were obtained from each sector respectively. 80%, 35%, and 91% of the respondents from educational sector (ES), health sector (HS), and engineering sector (CS) respectively have indicated that they like to have plants inside their rooms.

The respondents were asked to choose one or more reasons for their preference out of the reasons indicated. The list of reasons included visual comfort, physical comfort and psychological comfort. Figure 3.35 indicates the results for the reasons. It can be seen that majority of the respondents prefer to have plants inside as it creates a pleasant working environment.

However, it can be seen that the majority from the health sector prefer not to have plants inside. It can be mainly due to the cleanliness standards that have to be maintained inside the spaces.

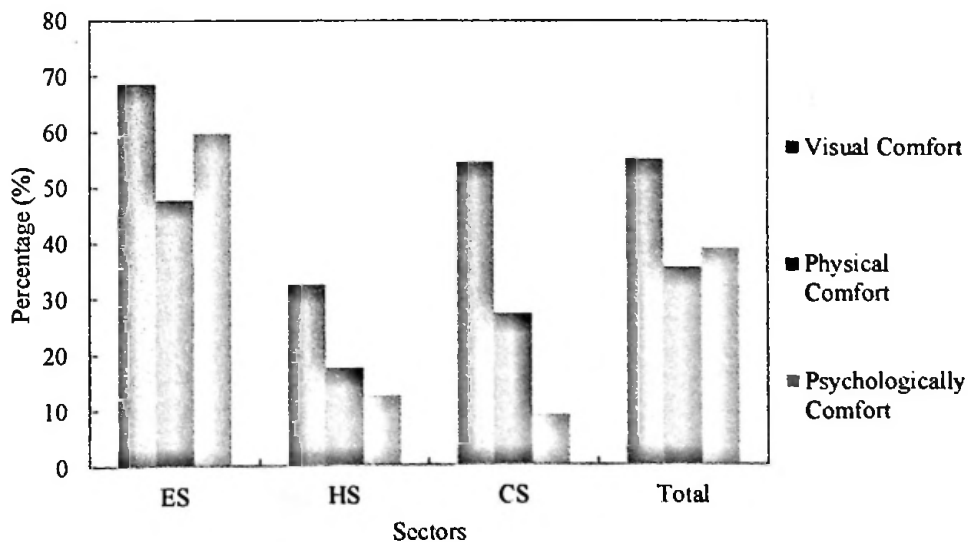

Figure 3.35: Reasons to have plants inside

### 3.6 Summary

Eventhough a large collection of literature suggests reduction in air pollutant concentration due to indoor plants, hardly any propose guidelines for building planners. In this study, an attention has been paid in developing user friendly guidelines for building planning based on factors affecting the CO<sub>2</sub> absorption by plants. The factors affecting the CO<sub>2</sub> absorption are based on theoretical development and several experiments in Sri Lankan context.

An equation was derived including the leaf area and absorption rate as parameters. This equation is based on the CO<sub>2</sub> balance in a mechanically ventilated room. Thus the frame work was developed for determination of CO<sub>2</sub> absorption rate. The frame work criteria identified can be summarized as indoor temperature, indoor relative humidity, lighting source and light level, leaf area density, existing CO<sub>2</sub> concentration and night time CO<sub>2</sub> emission.

Several conclusions relating to plant species can also be made based on the experiments carried out. Out of the two species used in the study Table palm has the highest performance in CO<sub>2</sub> absorption. The CO<sub>2</sub> absorption of plants exposed to sunlight is higher compared to other lighting combinations. Thus placing the Table palm near the window gives a higher benefit. It can be concluded that the CO<sub>2</sub> absorption by plants increase with the indoor concentration as well.

It has been identified that plants can act as a barrier for VOC dispersion in a room. Thus plants can be kept around stationary indoor sources such as photocopiers, printers etc.

Finally, it was identified that people prefer to have plants inside and they consider the plants are creating visual comfort. This will help in reducing the working stress and thus sick building syndrome.



## CHAPTER 4

### 4 EFFECT OF VEGETATION ON OUTDOOR MICRO-CLIMATE

Indoor micro-climate is highly affected by the outdoor micro-climate. Thus for the past few decades considerable amount of research has been conducted to create better outdoor micro-climatic conditions. In these studies it has been identified that specific geometry of man-made structures, vegetation, and water bodies can create a better outdoor micro-climate. However, these findings are subjected to local climatic conditions and geographical locations. Furthermore, strategies or guidelines for creating such micro-climates are hard to obtain from these studies.

This chapter focuses on several studies which are aimed to develop several strategies that can be adopted in the Sri Lankan context.

#### 4.1 Introduction

Vegetation affects the micro-climate in terms of balancing the temperature, relative humidity, and removing several air pollutants in the atmosphere. The increase of temperature in urban built-environment relative to surrounding rural environment, which is termed as the 'urban heat island effect', is mainly caused by the trapped long-wave heat radiation which is emitted by the heated man-made structures. Vegetation reduces this long-wave radiation by lowering the temperature of the structure through shading. It converts the net radiation in to latent heat other than the sensible heat through evapotranspiration (Dimoudi and Nikolopoulou 2003; Jones 1992). Conversely, water bodies also transform the solar radiation in to latent heat through evaporation. Moreover, water bodies reflect a considerable fraction of short-wave radiation to the upper atmosphere. Thus vegetation and water bodies assist in creating a better micro-climate in its vicinity.

In the past few decades suburbs of Colombo, the capital city of Sri Lanka, have been drawn the attraction for residential development. These suburbs which were once abandoned with large tree canopies acted as sinks for urban air pollutants. Recently, these suburbs have been converted to built-environments with limited number of scattered small green patches. Due to the increased demand for land, the paddy fields and the marshy lands which had an immense biodiversity have also been

replaced with buildable lands. Moreover, the extent of the water bodies have downsized due to the lack of maintenance and less attention paid to the importance of these micro-climatic features in maintaining the air quality and thermal comfort. Thus a proper residential management plan with a wholistic approach is needed.

With the attraction drawn to suburbs, the land prices have gone up rapidly persuading inhabitants to use the maximum extent of their land for built purposes. Hence the land left for favourable micro-climatic features (i.e. vegetation, water bodies) has been reduced. This has resulted in a decrease of thermal comfort and air quality levels in both indoor and outdoor climates.

A series of studies were developed in order to analyse the current situation and to propose several strategies for residential development with better micro-climates. An experimental study was conducted to investigate the actual conditions and the potential risk of poor indoor environmental quality of the suburbs. Subsequently, the study was extended to a numerical simulation to identify the strategies that can be adopted.

#### **4.2 Experimental Study on the Effect of Micro-climate on Thermal Comfort and Air Quality**

An experimental program was conducted in suburban residential buildings in order to study the current situation of the suburbs. This study was also aimed to identify effects of micro-climatic features and suitability of experimental programs in deducing strategies to plan better micro-climates. Hence the buildings were rationally selected based on the surrounding micro-climatic features.

##### **4.2.1 Study Location**

This study was carried out in the Kesbewa area which is situated in the southern periphery of Western province in Sri Lanka. Sri Lanka being a tropical country, this area is characterized by hot humid climatic conditions having sunshine throughout the day.

This area can be classified as semi-urban area due to the presence of green patches in the form of paddy fields and grooves in the developed area. Thus five samples were

carefully selected considering the presence of vegetation and water bodies nearby and the distance to the main road. The study area indicating the sample points is shown in Figure 4.1. Details of each sample are shown in the Table 4-1.

#### 4.2.2 Data Collection

In order to assess the level of air quality in the selected residential buildings, indoor concentrations of CO<sub>2</sub>, NO<sub>2</sub>, PM<sub>2.5</sub>, CO, and VOC were measured in two minutes interval throughout a day from 9.00 AM to 4.00 PM in each sample building. The temperature, relative humidity (RH) and wind speed were also obtained to perceive the thermal comfort inside. The data collection points were located in the middle of the living room in all the sites.

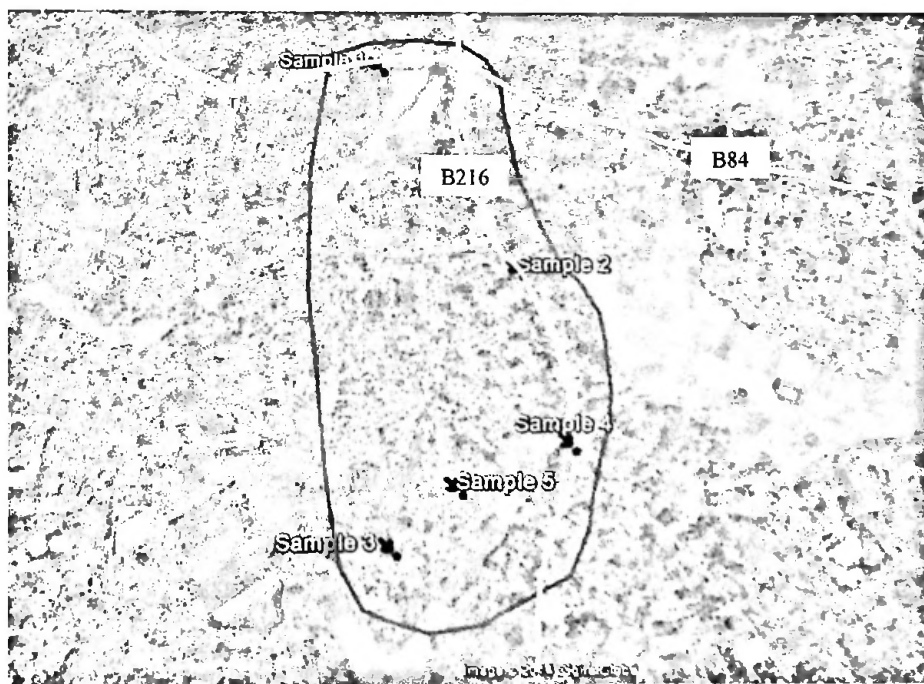

Figure 4.1: Site Map of the Study Area

The dimensions of the building and the amount of vegetation were measured to quantify the micro-climatic features in the vicinity of the building. The extent of micro-climate under consideration was limited to the extent of the land in which the building is situated. These micro-climatic features of selected samples were divided in to three main categories. The three main categories were;

- 1) Vegetative cover – The area of the land covered by vegetation

- 2) Hardscape – The area of the land covered by the building (plot coverage), concrete pavement and other man-made structures
- 3) Soil cover – The area of land left without vegetation or hardscape

The areas of these micro-climatic features are also given in the Table 4-1.

Outdoor temperature, relative humidity, wind speed and light level were also recorded in 30 minutes intervals to rationalize the deviations that could have occurred in observation due to the variations of daily climatic conditions.

#### **4.2.2.1 Analysis of the vegetative cover**

The effect of vegetation on micro-climate should be taken in to account in terms of horizontal distribution and vertical distribution. Hence the amount of vegetative cover was analysed considering the height of trees as well. Figure 4.2 illustrates the comparative distribution of micro-climatic features in the sample sites.

Site 1 has the most favourable microclimate towards the indoor air quality and thermal comfort with 61.4% of vegetative cover. With the presence of Kesbewa Lake nearby, this site can be identified as the best case scenario. Site 2 can be identified as the worst case scenario with 2.2% of vegetative cover having only three plants of 1m height and adjacent to the Bandaragama – Kesbewa main road which is an asphalt paved surface. Figure 4.3 shows the level of vegetation in site 1 (Best case scenario) and site 2 (Worst case scenario).

Even though site 4 is also having approximately the same percentage of vegetation compared to site 1, the vegetation in the site was clogged in the rear side of the building where the vegetation in the site 1 was distributed around the building providing a shade in every direction. Hence the effect of the vegetation on the indoor environment has reduced in site 4 compared to site 1.

**Table 4-1: Details of sample sites**

Sample Site	1	2	3	4	5
<b>Site Details</b>					
Area of the land (m <sup>2</sup> )	3125	90	500	975	250
Floor Area of the building (m <sup>2</sup> )	684	47	116	247	65
Plot coverage(%)	22%	52%	23%	25%	26%
<b>Data collection points</b>					
Area of the living room	68.70	14.85	24.40	52.80	41.25
Void to floor ratio	19%	30%	37%	15%	24%
<b>Micro-climatic features</b>					
Vegetative cover (%)	61%	2%	4%	54%	13%
Adjacent main road	B84	B216	B216	B216	B216
Distance from the site (m)	30	2	500	5	200
Daily traffic (No. of vehicles)	6500 – 7000	6500 – 7000	6500 – 7000	6500 – 7000	6500 – 7000

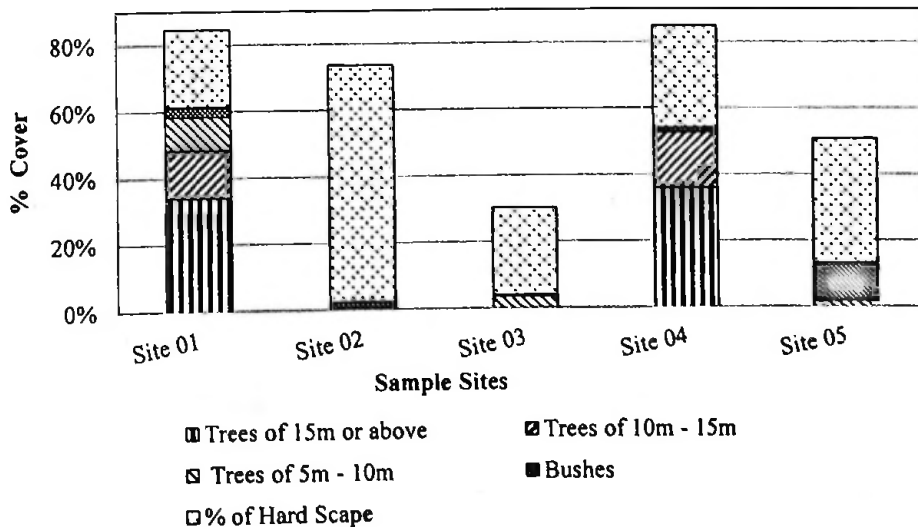

**Figure 4.2: Percentage of micro-climatic features in the Sites**





(a)



(b)

**Figure 4.3:** Level of vegetation in the selected sites [(a) – Site 1, (b) – Site 2]

#### **4.2.3 Results and discussion**

The air quality data obtained from the field measurements were initially checked against the threshold values of each pollutant to evaluate the level of air quality in residential buildings. Then they were compared with the existing micro-climatic conditions to identify the impact of micro-climate on indoor environmental quality.

##### **4.2.3.1 Level of indoor environmental quality**

The air quality in all the residential buildings is in the acceptable range except the  $PM_{2.5}$  concentration as shown in Table 4-2. Even though there were two occupants inside the room at the time of investigation, maximum  $CO_2$  concentration recorded was 600 ppm. It should be noted that all these residential buildings are naturally ventilated and the favourable level of  $CO_2$  concentration can be attributed to the natural ventilation provided.

Even though the recorded CO concentrations are well below the threshold value, it is advisable to maintain zero CO concentration conditions. It can be seen that the highest CO concentration was recorded in site 2 and data shows that there was a detectable level of CO throughout the day. This site is the closest to the main road having a distance of 2m from site. And 30% of the openings were in the wall facing the road. Thus the vehicular emissions caused detectable levels of CO concentrations.

There were no detectable VOCs in all the sites due to the absence of VOC sources in indoors.

**Table 4-2: Recorded range of the air pollutants inside the building**

Sites	Air quality parameter			
	CO <sub>2</sub> (ppm)	NO <sub>2</sub> (ppm)	PM <sub>2.5</sub> (mg/m <sup>3</sup> )	CO (ppm)
Site 1	413 - 498	0.023 – 0.039	0.002 – 0.065	0.00 – 0.06
Site 2	470 - 600	0.024 – 0.038	0.001 – 0.097	0.00 – 1.93
Site 3	447 - 542	0.021 – 0.031	0.001 – 0.025	0.00 – 0.02
Site 4	420 - 554	0.017 – 0.025	0.002 – 0.095	0
Site 5	399 - 541	0.017 – 0.027	0.001 – 0.040	0
Threshold level	1000	0.053	0.035	9

#### 4.2.3.2 Effect of micro-climatic features on air quality parameters

A considerable effect of micro-climate on air quality parameters was observed in this study. The impact on each parameter is described separately in the following sections.

##### 4.2.3.2.1 Temperature and relative humidity

The indoor temperature is directly affected by the outdoor temperature. Therefore the difference in indoor and outdoor temperature (Indoor temperature – Outdoor temperature) was considered in the comparison. The Figure 4.4 shows the temporal variation of temperature difference throughout the day. In site 1, the maximum temperature difference observed is 0.75<sup>0</sup>C. The site 2 has the highest temperature difference of 2.25<sup>0</sup>C having a higher temperature inside than that of outdoor throughout the day. Thus a reduction of temperature was observed in the best case scenario compared to the worst case with respect to the presence of vegetative cover.

The difference in indoor and outdoor RH (Indoor RH – Outdoor RH) is shown in Figure 4.5. The observation shows that no clear relationship can be found between the relative humidity and the vegetative cover.

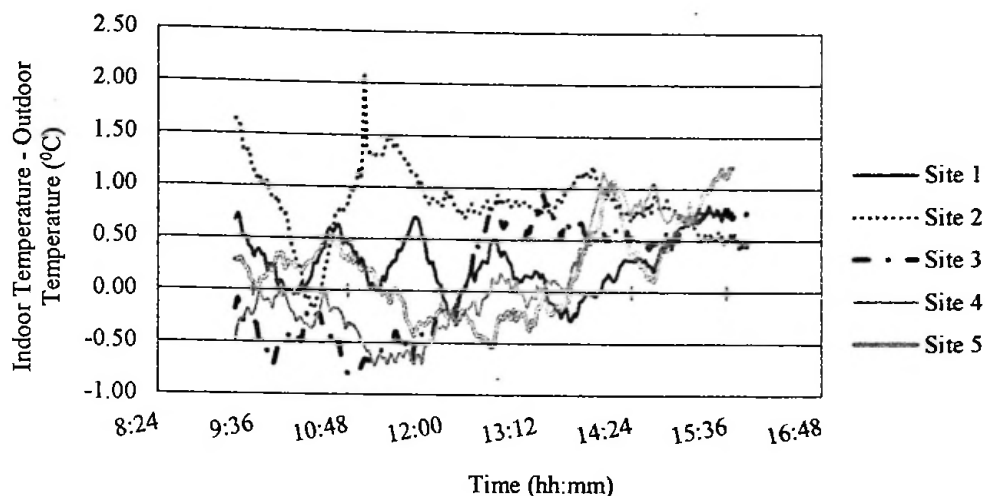

Figure 4.4: Variation of Indoor-outdoor temperature difference with time

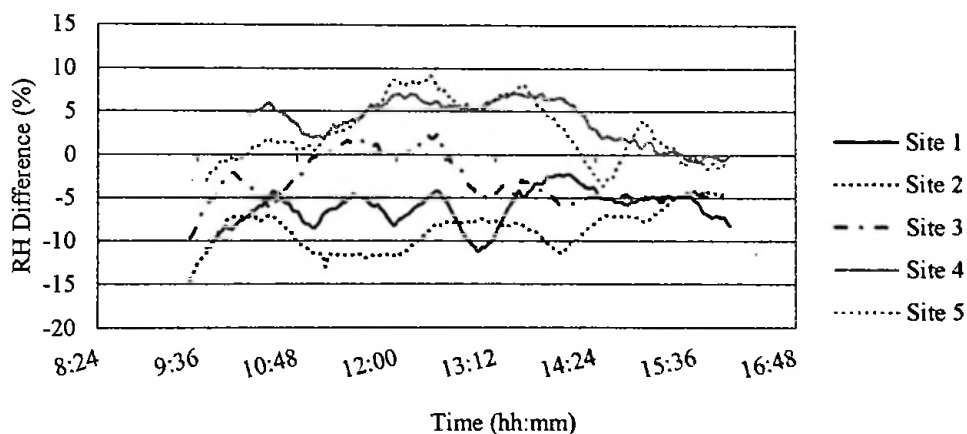

Figure 4.5: Variation of indoor-outdoor RH with time

#### 4.2.3.2.2 CO<sub>2</sub> Concentration

Figure 4.6 shows the Indoor CO<sub>2</sub> concentration / Outdoor CO<sub>2</sub> concentration ratio throughout the daytime. According to the Figure 4.6, site 1 and site 5 have the lowest Indoor/Outdoor CO<sub>2</sub> concentration. Site 1 has the maximum outdoor vegetative cover and it has helped to reduce the CO<sub>2</sub> concentration in outdoors. The moderate indoor and outdoor wind speeds of 0.15 ms<sup>-1</sup> and 0.27 ms<sup>-1</sup> respectively has resulted in creating the same CO<sub>2</sub> level inside compared to that outside. Although

site 05 has lesser vegetative cover, it has a comparatively higher indoor and outdoor wind speeds amounting to  $0.14 \text{ ms}^{-1}$  and  $0.49 \text{ ms}^{-1}$  respectively. Thus the indoor  $\text{CO}_2$  concentrations may have diluted as a result of proper air circulation inside. Site 2 has the highest indoor to outdoor  $\text{CO}_2$  level because of its poor ventilation and very low wind speeds of  $0.04 \text{ ms}^{-1}$  inside and  $0.19 \text{ ms}^{-1}$  outside. The absence of vegetation around the building has aggravated the issue.

#### 4.2.3.2.3 $\text{NO}_2$ Concentration

Figure 4.7 shows the indoor  $\text{NO}_2$  variation in selected sites. Site 1 and site 2 have shown a similar variation, having lower  $\text{NO}_2$  concentration in the morning with the increase concentration towards day time. Moreover, the highest  $\text{NO}_2$  concentration was recorded in the site 1 and site 2 compared to the other sites. Hence a strong relationship between the  $\text{NO}_2$  concentration and vegetation could not be established since site 1 and site 2 have the maximum and minimum vegetative cover respectively. However this observation can be linked with the distance from the main road. Site 1 is situated nearly 30m away from the main road and there is a fuel station at the distance of about 50m from the site 1. Site 2 is located only 2m away from the road and the entrance of the building is directly opened to the main road. It can be observed that these features have attributed to the higher  $\text{NO}_2$  concentration inside the building located in site 1 and site 2 than in the other sites. However, it should be noted that all the sites have recorded lesser  $\text{NO}_2$  concentrations than the maximum permissible level of 0.053 ppm.



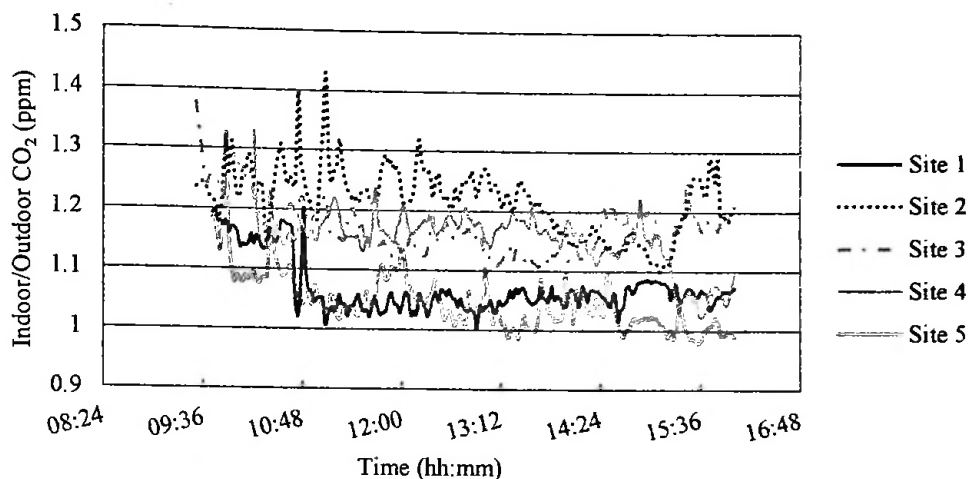

Figure 4.6: Variation of Indoor-outdoor CO<sub>2</sub> with time

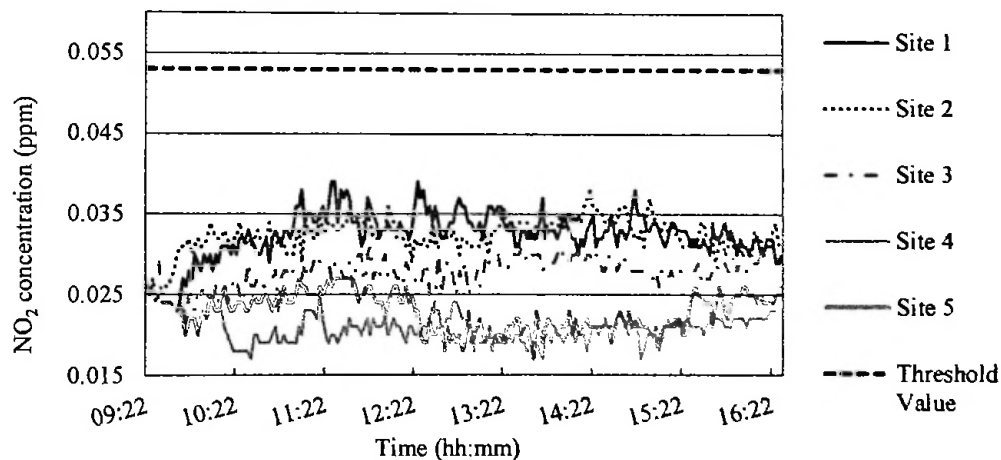

Figure 4.7: Variation of NO<sub>2</sub> concentration with time

#### 4.2.3.2.4 PM<sub>2.5</sub> Concentration

The daily variation of PM<sub>2.5</sub> concentration is shown in Figure 4.8. It can be observed that site 2 has the highest average PM<sub>2.5</sub> concentration of 0.014 mg/m<sup>3</sup> with the highest peak value and values exceeding the threshold limit in greater frequency. The site 3 has the lowest average PM<sub>2.5</sub> concentration of 0.004 mg/m<sup>3</sup> peaking only once beyond the threshold level. It should be noted that site 2 is the closest to the main road, being only 2m away and site 3 is the furthest to the main road.

Figure 4.9 shows the daily averages of  $PM_{2.5}$  concentration plotted against the distance to the main road. A declining trend of  $PM_{2.5}$  concentration with the increase of the distance can be clearly observed.

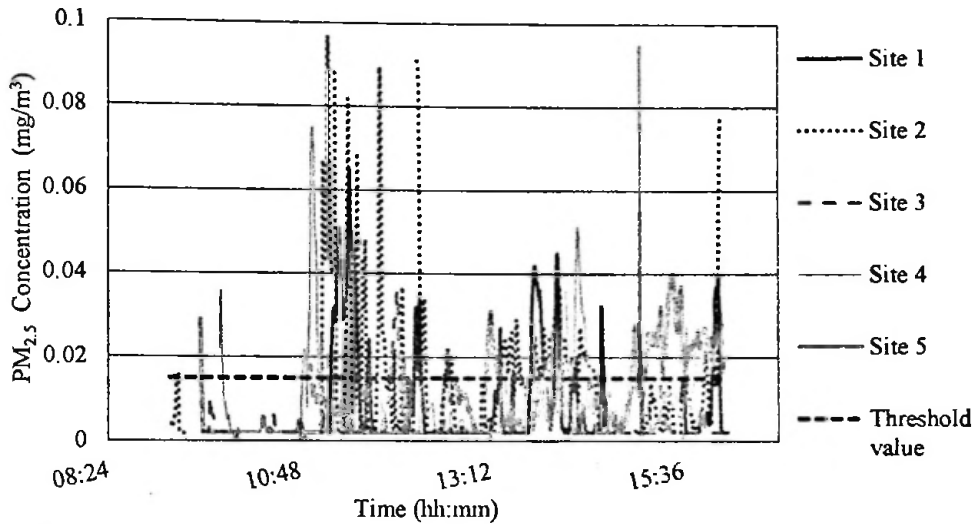

Figure 4.8: Variation of  $PM_{2.5}$  concentration with time

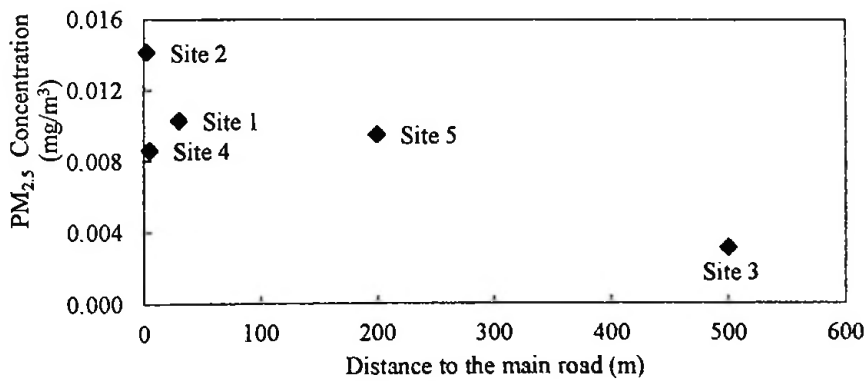

Figure 4.9:  $PM_{2.5}$  concentration variation with the distance to the main road

#### 4.2.3.3 Effectiveness of experimental studies on outdoor micro-climate

The experimental study has shown that the air quality level in suburbs is still in the acceptable levels. However, a risk of increase in  $PM_{2.5}$  levels has been projected. Thus it can be concluded that experimental studies are good in depicting the existing conditions.

However, it has been identified that the indoor and outdoor air quality and thermal comfort can be affected by the vegetative cover around the building and distance to the main road. In some cases observed effects may have been caused due to both reasons. Thus it is hard to define the effect of a single micro-climatic feature from this study.

Moreover these sites can be ranked considering the presence of vegetation. However, the air quality and the thermal comfort levels have not followed the same order. This is mainly due to the presence of complex combinations of several micro-climatic features such as,

- The climatic condition of the day
- The presence of air pollutants source nearby (Traffic, Industrial plant, Construction site)
- The presence of sinks in the vicinity (Forests, rivers etc...)
- Wind speed and direction
- Shading provided by buildings in proximity
- The nature of the non-vegetative area (Soil, sand, concrete pavement etc.)

The heat absorption and emission, air pollutant absorption, emission, and dispersion vary drastically with the presence of these conditions. Thus evaluation of the effect of each micro-climatic condition is difficult. It requires long term measurements for a considerable sample size to conclude its effects. Even though long term field measurements are good at revealing the current situation they may not be helpful in forecasting the effects of the changes of any feature. Hence setting up guidelines could not be done based solely on field measurements.

Conversely, physical models can be used with wind tunnel testing to simulate the micro-climatic conditions caused by buildings. This also consumes a considerable amount of resources and for countries like Sri Lanka this will not be a viable solution. Thus a computer simulation was carried out in order to study several strategies to plan and design better micro-climates.



### **4.3 Computer Simulation of Outdoor Micro-climate**

Since air can be considered as a fluid, computational fluid dynamic analysis can be used to model indoor or outdoor air flows. Computational fluid dynamics (CFD) uses algorithms generated by numerical methods to model the fluid flow. With the development of simulation software, numerical simulations are gaining trust on its' consistency and popularity on time and resource savings. Numerical simulations have become more consistent with the introduction of finite element analysis conversely to the finite difference method and finite volume method which have been using for numerical modelling (Pepper and Carrington 2009).

There are several CFD based software packages which can be utilized for micro-climatic simulation. Among the software available, ENVI-met, a CFD based software has been selected for this study considering its benefits discussed in the Section 2.5.3.

In this study a model was developed to simulate the micro-climatic features and it was validated using field measurements. The validated model was subjected to a parametric analysis to obtain guidelines for planning micro-climates.

#### **4.3.1 ENVI-met Software Package**

ENVI-met is a CFD based micro-climate simulation tool developed by Prof. M. Bruse and team from University of Mainz. According to the developers it can be used to model flow, turbulence, and particle and substance dispersion around buildings. The spatial resolution varies from 1-10 m horizontally while vertical resolution is customizable. The temporal resolution is 10s.

##### **4.3.1.1 Models in ENVI-met**

ENVI-met comprises of a number of models found by various other researchers. These models can be described as,

- Atmospheric model – This consists of the algorithms to model the surrounding atmosphere. The air flow is modeled using Navier-Stroke equations (Equation 5-1 to Equation 5-3) to simulate the turbulence.

$$\frac{\partial u}{\partial t} + u_i \frac{\partial u}{\partial x_i} = \frac{\partial p}{\partial x} + K_m \left( \frac{\partial^2 u}{\partial x_i^2} \right) + f(v - v_g) - S_u$$

$$\frac{\partial v}{\partial t} + u_i \frac{\partial v}{\partial x_i} = \frac{\partial p}{\partial y} + K_m \left( \frac{\partial^2 v}{\partial x_i^2} \right) + f(u - u_g) - S_v$$

$$\frac{\partial w}{\partial t} + u_i \frac{\partial w}{\partial x_i} = \frac{\partial p}{\partial z} + K_m \left( \frac{\partial^2 w}{\partial x_i^2} \right) + g \frac{\theta(z)}{\theta_{ref}(z)} - S_w$$

Where,

$f$  = Coriolis parameter

$p$  = local pressure perturbation

$\theta$  = potential temperature at level  $z$

$\theta_{ref}$  = reference temperature

$u_i$  = three dimensional advection term

$x_i$  = three dimensional diffusion term

$S_n$  = local sink / source terms ( $n=u,v,w$ )

The additional turbulence occurring due to plants is also simulated in this model. The temperature and humidity is estimated using combined advection and diffusion equation with internal sources and sinks. The simulation of radiative fluxes is carried out using empirical equations.

- Plant model – For plant the software uses the A-gs model.
- Soil model – This is organized in 14 layers having the lower boundary as 2 m. Under this only the water and heat transfer is being modeled.

#### 4.3.1.2 Structure of ENVI-met

ENVI-met consists of several types of files, such as,

- Input files
  - Area input file –This file consists of a graphical user interface allowing the user to define geographic positions on earth, locations of building and vegetation etc. Building and vegetation, soil or ground surface, pollutant sources and receptors are defined in separate layers.
  - Main configuration file –This file defines the setting for simulation, i.e. output file locations, total simulation time, temporal resolution, initial climatic condition, etc.

- Database – ENVI-met has inbuilt databases by default for simulation purposes. These databases can be customized to suit the conditions in the simulation. The five types of databases are,
  - Sources – In this database, additional air pollutant sources can be defined in terms of the type of the source (point, line or area), height of the source and hourly emission for 24 hours.
  - Plants – This database contains the information about vegetation such as, carbon fixation path, height of vegetation, distribution of leaves throughout the crown, root profiles etc.
  - Soil – This database allows defining soil types based on water content, hydraulic conductivity, and heat conductivity of soil. Different surface finishing types can be defined based on the heat conductivity.
  - Profile – This database is linked with the soil database to define the soil profiles in the simulation. It defines the sequential presence of the soil types.
  - Local – All other databases are default databases that have been created through thorough researches. However, a local plant type or soil type may be needed. These can be added to the main database or additional databases.
- Output files – ENVI-met outputs an enormous amount of data. The main types of files are,
  - 3-dimensional output files– This file consists of turbulence data, temperature data, solar radiation data, pollutant dispersion data etc. in each grid point vertically and horizontally. The data will be saved over defined time periods.
  - Receptor files – This consists of all output data vertically at one location in the horizontal grid. This file is important when data is required at a specific point.

An illustration of the file structure is shown in Figure 4.10.

#### **4.3.1.3 Limitations of ENVI-met**

The limitations of ENVI-met can be identified as,

- Default vegetation profiles may not accurately represent local species
- All the buildings have a single albedo and heat transmission value

- The building base height cannot be defined in the free version of ENVI-met. This will have an adverse effect in sloped ground profiles

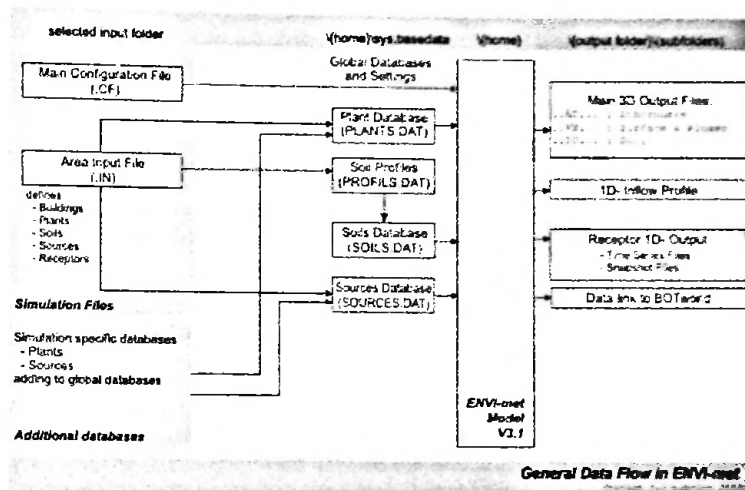

Figure 4.10: ENVI-met structure (Source: ENVI-met manual)

### 4.3.2 Study location

The selected area for the study was the Civil Engineering Complex (CEC) of the University of Moratuwa. This area can be considered as a suburb of the Colombo city. This area is bordered by the Bolgoda River from the East and several buildings and vegetation from the other sides as shown in Figure 4.11.

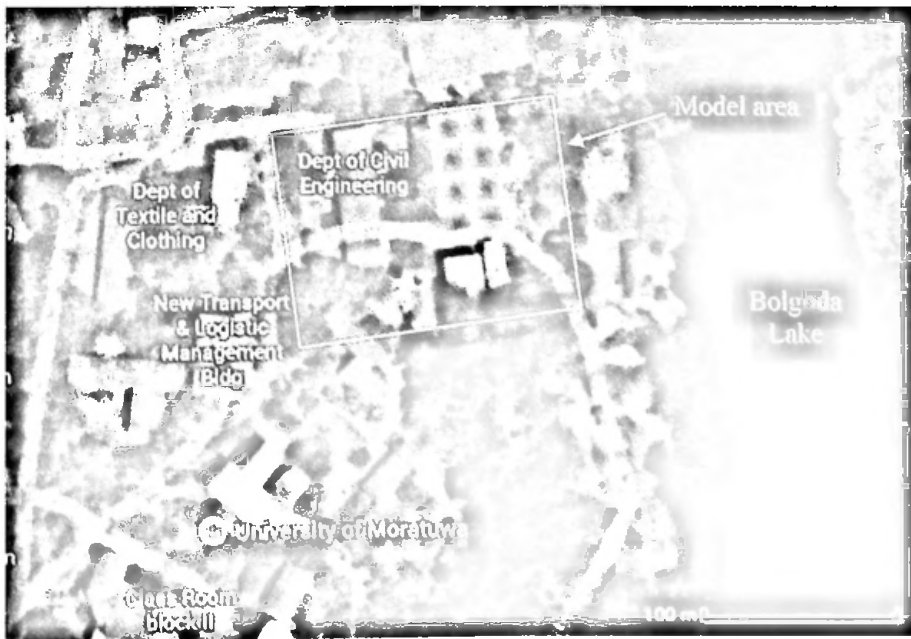

Figure 4.11: The Google map image of the study area

### 4.3.3 Model development

In the computer simulation extra attention is required in developing a realistic model. Thorough literature reviews were carried out in developing the model to furnish the most suitable parameters. An attempt was made to overcome the limitations as well.

Input data for the model was gathered from various sources. Site surveys, visual surveys, and Google images were used in locating the features in the model. Experimental data collection was carried out to determine realistic input parameters. A detailed explanation can be found in the following sections.

#### 4.3.3.1 Spatial and temporal parameters

The geographical position should be included in the model in order to model the sun's path and to calculate the solar radiation received. The geographical position of the study is  $6.80^{\circ}$  N (latitude) and  $79.90^{\circ}$  E (longitude). The simulation was carried out for a day in December since the model validation data obtained was in the month of December.

The model area was chosen as  $165\text{ m} \times 115\text{ m}$  which covers 3 times area as of the CEC foot print. The demarcated model area is shown in the Figure 4.11. The horizontal grid resolution is  $1\text{ m} \times 1\text{ m}$ . Since the maximum height of the trees and buildings is 25 m the model height was set to 50 m. An equidistant grid type was used as the vertical grid type having a  $\Delta z$  of 5 m as shown in Figure 4.12. The temporal resolution was used as 1 hour for 3D output files and 30 minutes for receptor files.

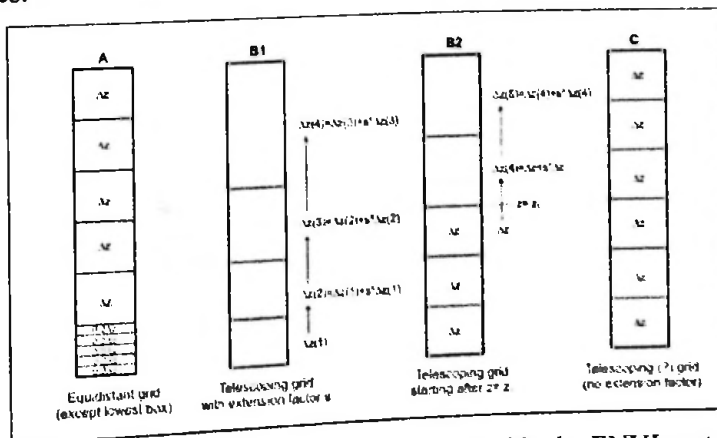
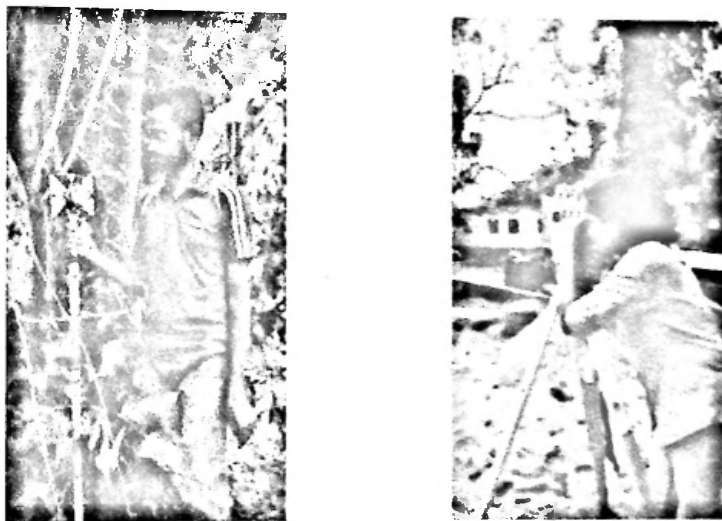

Figure 4.12: Vertical grid types specified in the ENVI-met

#### 4.3.3.2 Buildings and vegetation

A detailed survey has been carried out to obtain the geometry of the building, location of vegetation, height of the building and the height of vegetation. Those were obtained using a total station instrument as shown in Figure 4.13.

In ENVI-met the vegetation should be defined based on the leaf area density (LAD) profile as a tree is considered to be a vegetative block having different LADs in 10 layers. This is illustrated in Figure 4.14.



**Figure 4.13:** Obtaining 3-dimensional input coordinates

Since the default vegetation in the ENVI-met may not represent the local species, the LAD profiles for vegetation in the vicinity was deduced using the obtained tree heights, crown profile and the LAD profiles suggested for similar species. The LAD profile calculation can be found in Annex C. The model area was developed using these tree types and buildings as shown in Figure 4.15. LAD profiles defined in the simulation are shown in the Table 4-3. All the trees were considered as  $C_3$  types as they are common types that can be found in general.

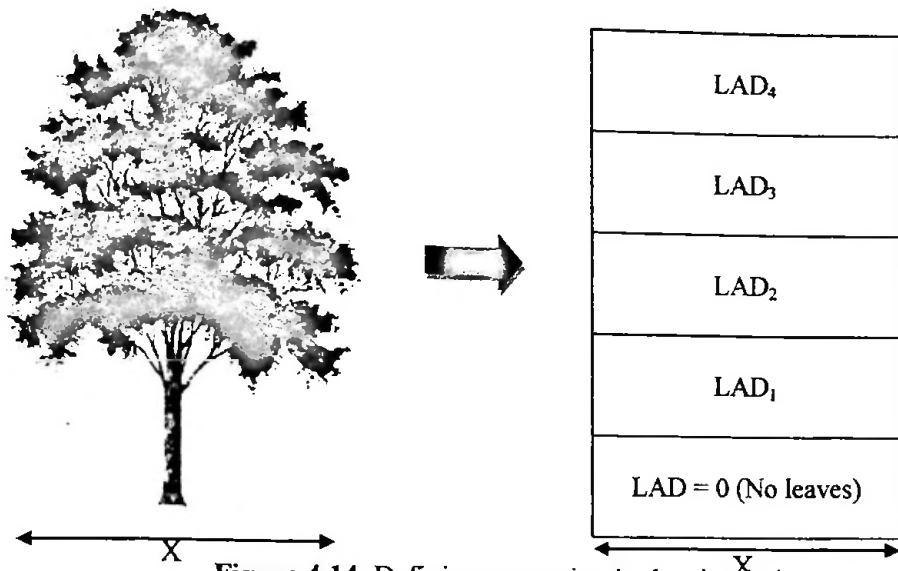

Figure 4.14: Defining vegetation in the simulation

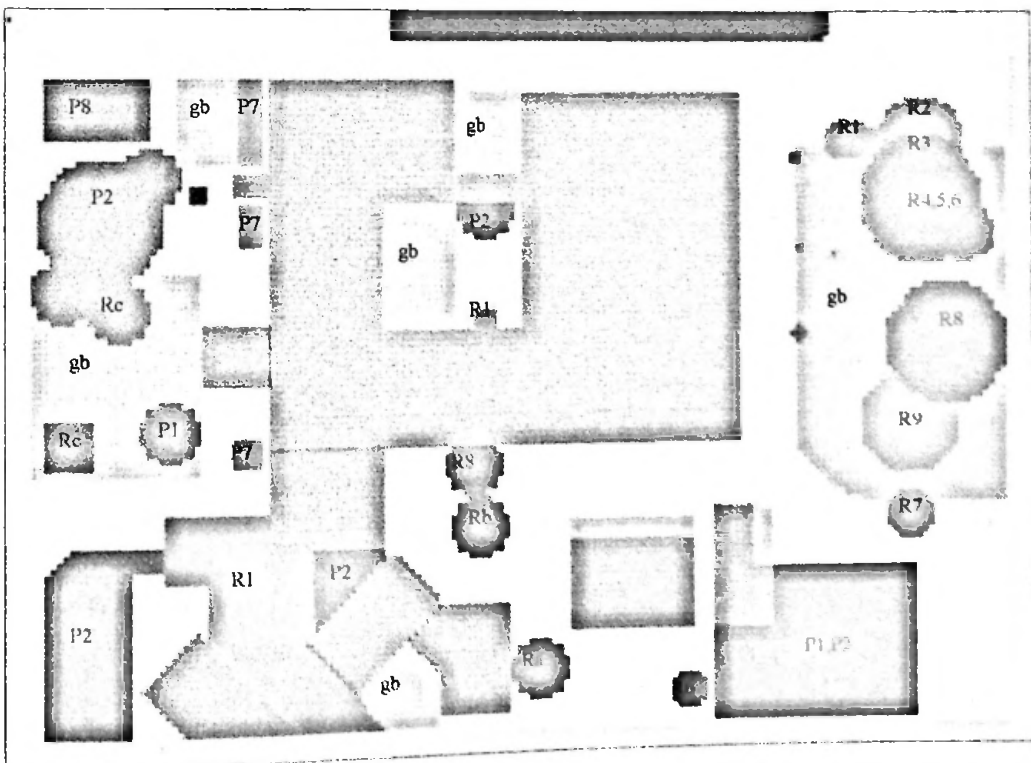

Figure 4.15: Defined model area for ENVI-met simulation building (Ash colour) and vegetation (Green Colour)

**Table 4-3: Vegetation profiles defined in the ENVI-met**

Vegetation Code (Figure 4.15)	Height (m)	LAD1 (m <sup>2</sup> /m <sup>3</sup> )	LAD2 (m <sup>2</sup> /m <sup>3</sup> )	LAD3 (m <sup>2</sup> /m <sup>3</sup> )	LAD4 (m <sup>2</sup> /m <sup>3</sup> )	LAD5 (m <sup>2</sup> /m <sup>3</sup> )	LAD6 (m <sup>2</sup> /m <sup>3</sup> )	LAD7 (m <sup>2</sup> /m <sup>3</sup> )	LAD8 (m <sup>2</sup> /m <sup>3</sup> )	LAD9 (m <sup>2</sup> /m <sup>3</sup> )	LAD10 (m <sup>2</sup> /m <sup>3</sup> )
R1	12	0.570	1.230	1.730	1.900	1.630	1.330	0.880	1.350	1.330	0.000
R2	10	0.085	0.255	0.395	0.495	0.530	0.385	0.215	0.110	0.050	0.000
R3	25	0.090	0.290	0.565	0.835	1.085	1.060	0.620	0.430	0.100	0.000
R4	25	0.090	0.290	0.480	0.580	0.590	0.530	0.235	0.050	0.000	0.000
R5	25	0.180	0.580	0.960	1.160	1.460	1.435	1.635	1.800	0.800	0.000
R6	15	0.495	1.100	1.405	1.405	1.405	1.785	1.860	0.400	0.050	0.000
R7	08	0.200	1.100	1.900	1.300	0.900	0.200	0.000	0.000	0.000	0.000
R8	23	0.120	0.360	0.505	0.485	0.375	0.260	0.135	0.050	0.000	0.000
R9	14	0.120	0.340	0.580	0.860	1.120	1.360	1.000	0.000	0.000	0.000
Ra	25	0.180	0.580	0.960	1.160	1.180	1.060	0.470	0.050	0.000	0.000
Rb	18	0.256	0.770	1.184	1.344	1.470	1.530	1.600	1.050	0.000	0.000
Rc	15	0.600	0.600	0.600	0.000	0.000	0.000	0.000	0.000	0.000	0.000
P1	23	1.250	1.900	2.184	1.700	1.100	0.730	0.600	0.350	0.200	0.100
P2	23	0.700	1.650	1.800	1.150	0.470	0.000	0.000	0.000	0.000	0.000
P7	08	1.256	1.970	2.500	1.700	1.100	1.530	1.600	1.050	0.000	0.000
P8	20	2.000	2.180	2.180	2.180	2.000	0.000	0.000	0.000	0.000	0.000
gb	00.50	0.300	0.300	0.300	0.300	0.300	0.300	0.300	0.300	0.300	0.300
H2	02	2.000	2.000	2.000	2.000	2.000	2.000	2.000	2.000	2.000	2.000

#### 4.3.3.3 Soil profiles

In ENVI-met both natural soil and soil surface finishing materials such as concrete, granite, tiles, bricks, asphalt etc. are defined under the 'Soil' section. ENVI-met defines natural soil properties in terms of water content, hydraulic conductivity at saturation and volumetric heat capacity. The properties of different surface finishing materials are defined in terms of the heat conductivity. In this study these default properties are used. The ground is defined as soil profiles which comprise of soils and surface finishing materials. The profiles defined in all the models are,

1. Asphalt pavement
2. Concrete pavement
3. Sandy soil
4. Loamy soil
5. Cement stabilized earth (CSE) road

The properties and the arrangement of these profiles are shown in Figure 4-16.

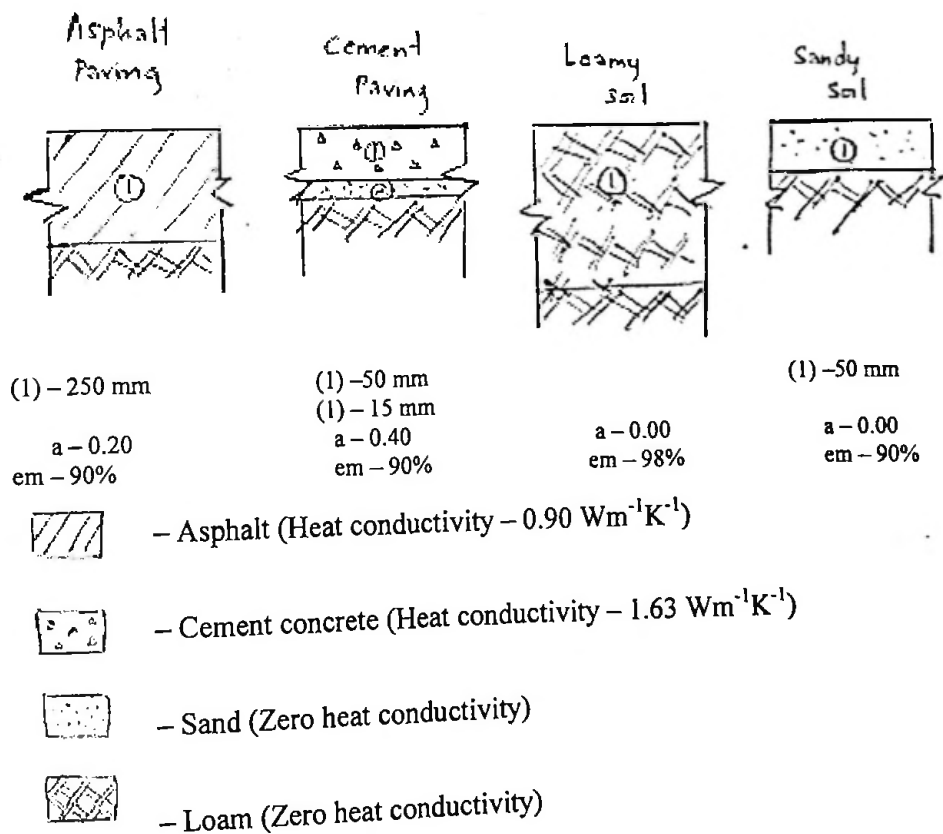

Figure 4.16: Soil profiles used in the ENVI-met models

#### 4.3.3.4 Other input atmospheric parameters

The initial atmospheric parameters are required to be included in the model in order to localize the simulation. These parameters were obtained from various sources such as field measurements, previous studies carried out in Colombo, default values given in the ENVI-met. Those parameters are shown in the Table 4-4 with the references where necessary.

**Table 4-4:** Description of input parameters

Parameter	Value	Reference
Latitude	6.80° N	
Longitude	79.90° E	
Date of simulation	16 <sup>th</sup> December	
Short wave Solar radiation (Maximum)	900 Wm <sup>-2</sup>	Sirimanna 2011
Simulation starting time	18:00 hrs	
Initial atmospheric temperature	302 K	Field measurement
Wind speed in 10 m above ground	0.85 m/s	Field measurement calibrate as in Section 4.3.4.2
Wind direction	85°	Field measurement
Relative humidity in 2m	70%	Field measurement
Specific humidity in 2500m	7 g per 1 kg of air	Envi-met Default value
Initial soil temperature	301 K	Emmanuel, 2004
Atmospheric CO <sub>2</sub> concentration	385 ppm	Field measurement
Heat conductivity of walls	1.74 Wm <sup>-2</sup> K <sup>-1</sup>	Emmanuel, 2004
Albedo of the wall	0.2	Emmanuel, 2004
Heat conductivity of walls	3.3 Wm <sup>-2</sup> K <sup>-1</sup>	Emmanuel, 2004
Albedo of the wall	0.3	Emmanuel, 2004

Some parameters were subjected to calibration using the verified model in order to obtain the most suitable parameters for the studies.

#### 4.3.4 Model verification

In general, verifications have been carried out based on temperature. Costa et al. have used wind speed for verification since their study had focused on pollutant dispersion (Costa Rasia and Krüger 2010). In this study model verification was carried out based on both temperature and wind speed.

##### 4.3.4.1 Field measurement

Five stations were set around the CEC in order to measure climatic conditions as shown in Figure 4.17. In Station 2 and Station 3 dry-bulb temperature, wet-bulb temperature, CO<sub>2</sub> concentration, wind speed, and the light intensity (LUX) were obtained. In Station 4 above parameters were obtained except wind speed. In Station 1 and 5 only the wind speed was obtained. Details are shown in the Table 4-5.

Station 1 was located 22m above ground in order to obtain an undisturbed wind profile. All other stations were located 1m above ground. Measurements were taken from 9.00 am to 5.00 pm at 45 min interval. Figure 4.18 and Figure 4.19 show the arrangements made for field measurements of climatic parameters.

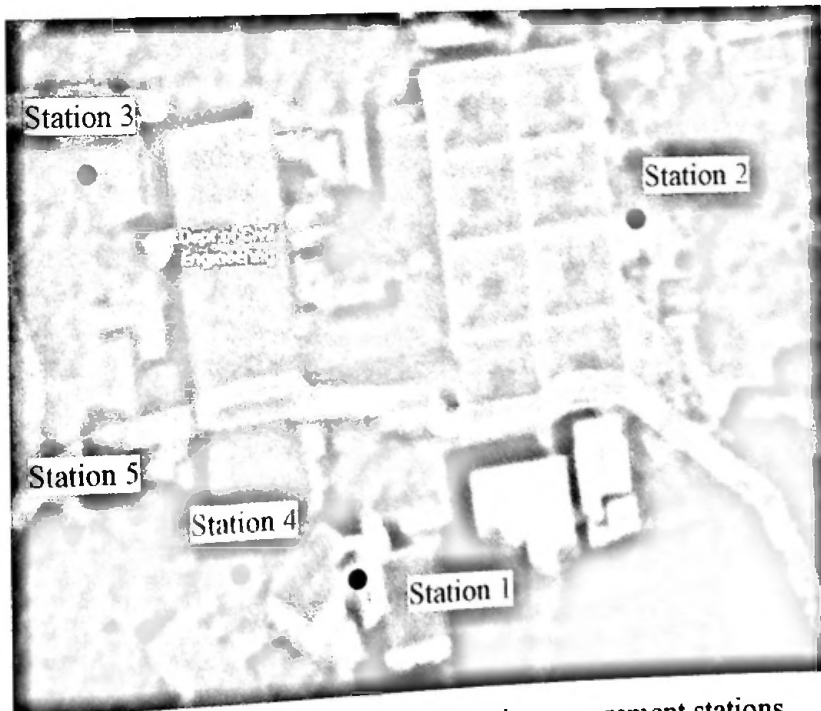

Figure 4.17: Locations of the climatic measurement stations

Table 4-5: Details of climatic stations

Station	Height from the ground	Distance from the building perimeter
Station 1	22 m	25 m
Station 2	1 m	8 m
Station 3	1 m	15 m
Station 4	1 m	5 m
Station 5	1 m	25 m

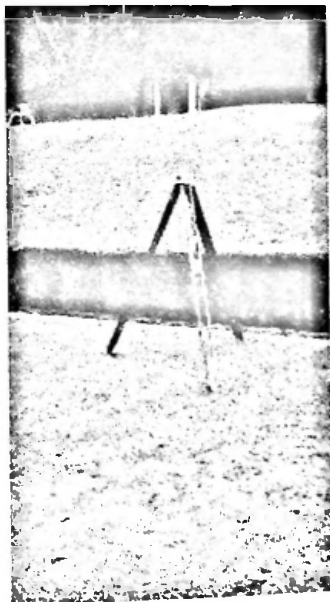

Figure 4.18: Arrangement of the climate measuring stations (a) Station 3 (b) Station 4

2



Figure 4.19: Measuring the wind speed in Station 1

#### 4.3.4.2 Model verification using wind speed

In the model, receptors were located at the station locations in order to compare the model performance and actual performance.

Initially, wind speed at 10m height was changed to tally the model wind speed with the actual wind speed in located stations. The actual station was not established at the 10 m height since undisturbed wind speed could not be obtained at that height. Instead, the wind speed at 10 m was changed to tally the model wind speed at station 1 with the actual wind speed at 22 m height. Then the other three locations were compared with the model results.

Figure 4.20 shows the model wind speed, considering the wind speed at 10 m as  $0.85 \text{ ms}^{-1}$ , and actual wind speed along with the minimum and maximum wind speed obtained. It can be seen that actual wind speeds have higher variation than the model obtained. The dashed line shows the points where the model and the actual wind speed must be equal. Except

for station 5, in all the other stations actual wind speed has been simulated well by the model. At station 5 the actual wind speed is greater than the model wind speed.

Figure 4.21 shows the wind profile around the building at 1m height. In the simulation, the wind pattern has not shown much variance throughout the day. The red arrows drawn in the same figure represent actual wind direction. It can be seen that the actual wind directions are well matched with that of model except at station 5.

One of the main limitations in the ENVI-met is its incapability of introducing open floors which are only having columns without infill walls i.e. car parks, large naturally ventilated cafeteria. In the actual scenario the Eastern face of the building with respect to station 5, consists of the ground floor car park which allows undisturbed wind to flow from the East, where in the model this component is restricted. This could be the reason for the observed increase of wind speed in the actual scenario.

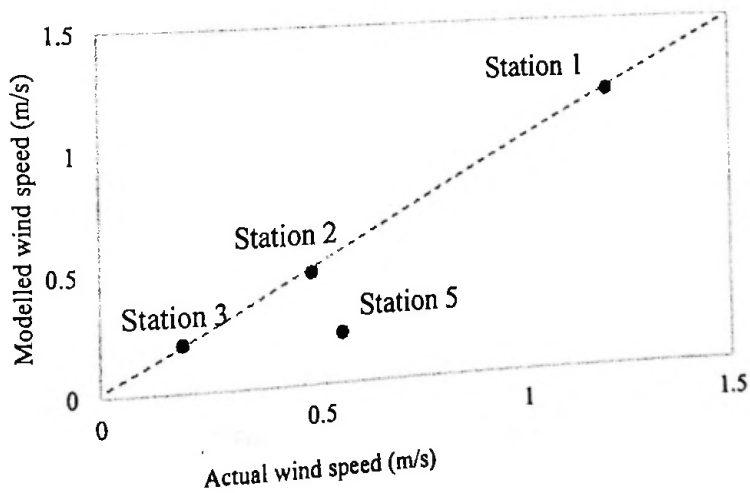

Figure 4.20: Actual wind speed vs. model wind speed

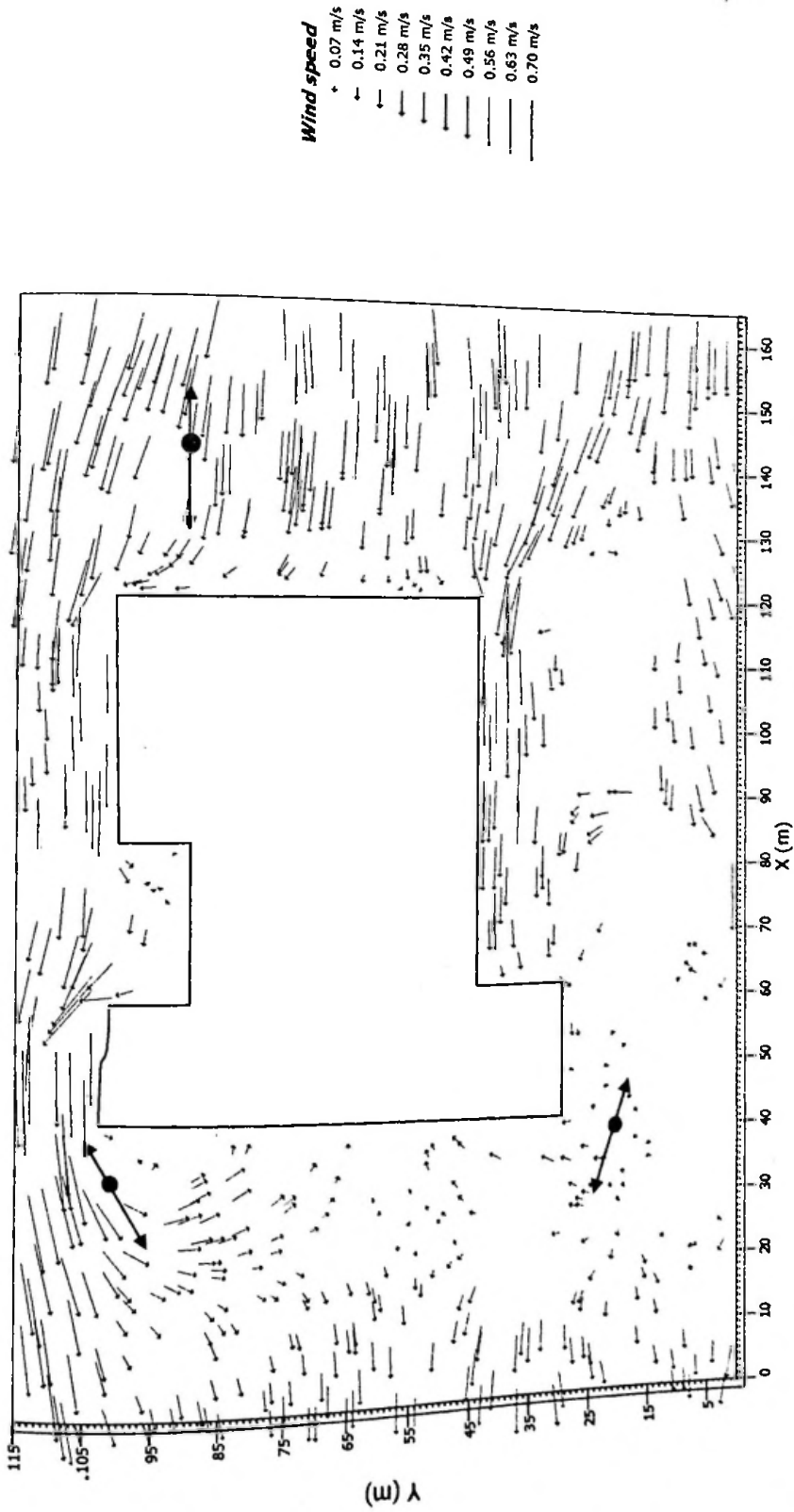

Figure 4.2.1. Modeled wind profile around the building and the observed wind directions (Red arrows) in the stations



#### 4.3.4.3 Model verification using temperature

Subsequently, the model and actual temperatures were also compared. Figure 4.22 to Figure 4.24 show the variation of actual temperature and model temperature from 9.00 am to 5.00 pm at climate stations around the building. The light intensity measured at the stations was indicated in the same graph.

It can be clearly seen that the actual temperature reading is higher at high light intensities. This can be mainly due to the increase of temperature of the thermometer due to the exposure to direct solar radiation.

Conversely, a considerable number of literature supports the statement that ENVI-met underestimates the maximum temperature and diurnal temperature variation by 1-2 °C (Emmanuel 2004, Jansson 2006, Elnabawi 2013, Spangenberg 2008). However, those studies have been continued with parametric variations to obtain useful strategies related to orientation of street canyons, optimum height to width ratio of high rise building complex, vegetation in the urban city limits, effective albedo values for buildings and pavements etc. Thus it can be concluded that the ENVI-met results are reliable for parametric studies.

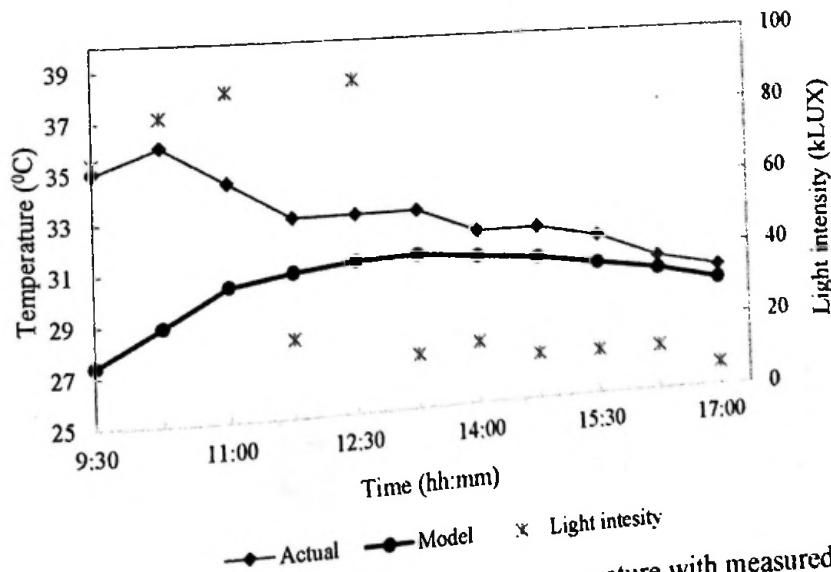

Figure 4.22: Actual temperature and modeled temperature with measured light intensity at station 2

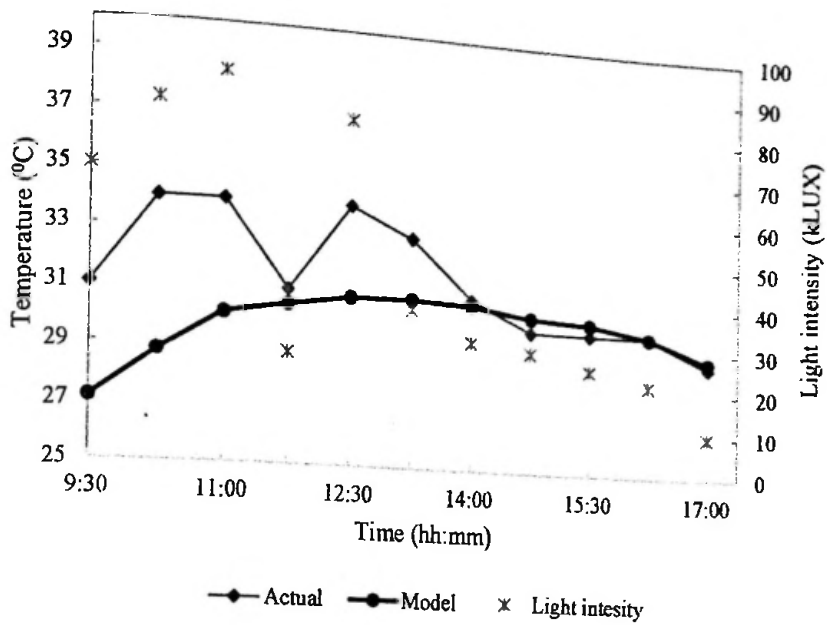

Figure 4.23: Actual temperature and modelled temperature with measured light intensity at station 3

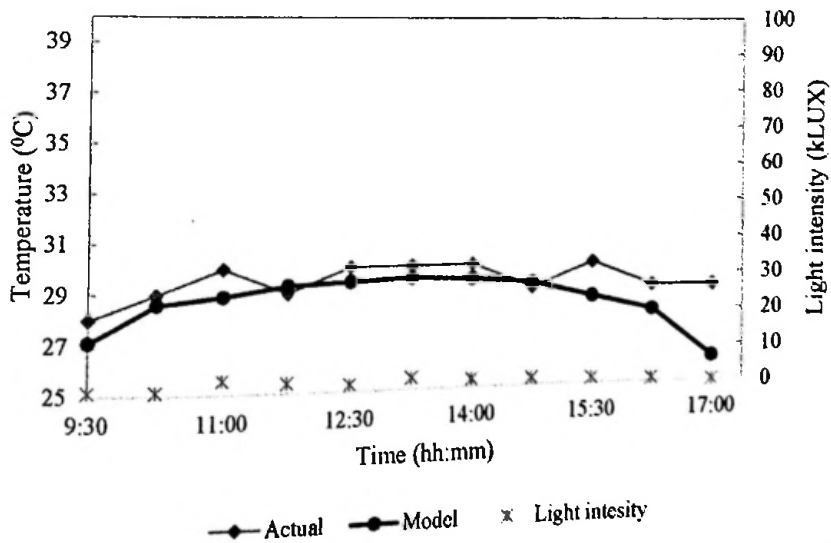

Figure 4.24: Actual temperature and modelled temperature with measured light intensity at station 4

#### 4.3.4.4 Model performance in estimating atmospheric CO<sub>2</sub> concentration

Figure 4.25 to Figure 4.27 shows the actual and model atmospheric CO<sub>2</sub> concentration. It can be seen that the actual CO<sub>2</sub> concentration in all three stations are in the same range amounting to 395 ppm on average. A constant reading was observed in all the stations.

In the model it is assumed that the air flow blows from the eastern side with a concentration of 385 ppm. The CO<sub>2</sub> variation at the station 2 and station 3 is in the same range. However, the modelled CO<sub>2</sub> concentration in the station 4 is considerably low compared to the other two stations. Station 4 is located in a dense vegetative area as shown in Figure 4.17. Thus it can be concluded that the model exhibits a reduction of CO<sub>2</sub> concentration with the presence of trees. However, the actual results have not shown a reduction in CO<sub>2</sub> concentration with the presence of vegetation. This can be mainly due to the presence of various CO<sub>2</sub> sources in the real world such as human, vehicles where such source cannot be modelled in the ENVI-met. Thus it can be concluded that the ENVI-met shows the CO<sub>2</sub> absorption capacities by the plants.

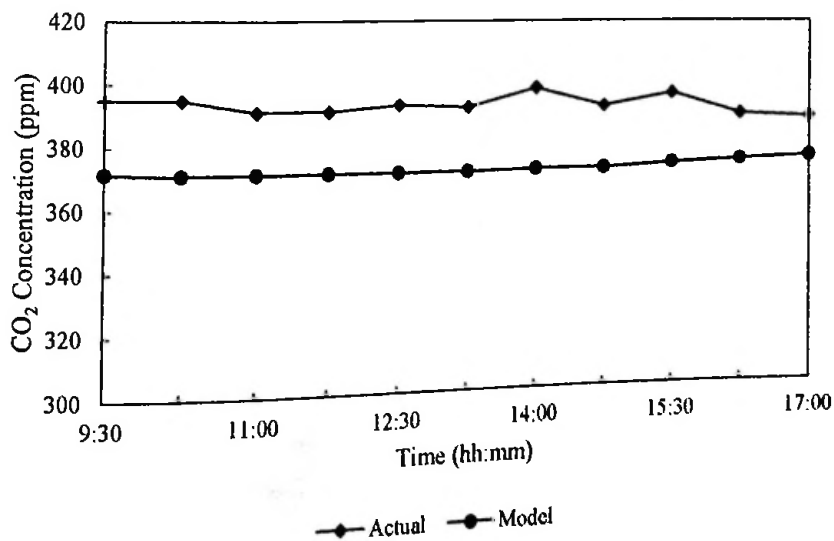

Figure 4.25: Actual CO<sub>2</sub> concentration and modeled CO<sub>2</sub> concentration at station 2



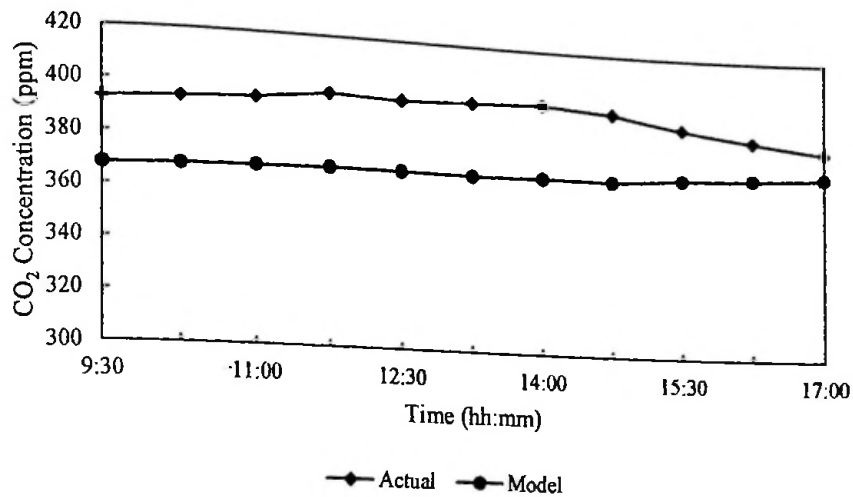

Figure 4.26: Actual CO<sub>2</sub> concentration and modelled CO<sub>2</sub> concentration at station 3

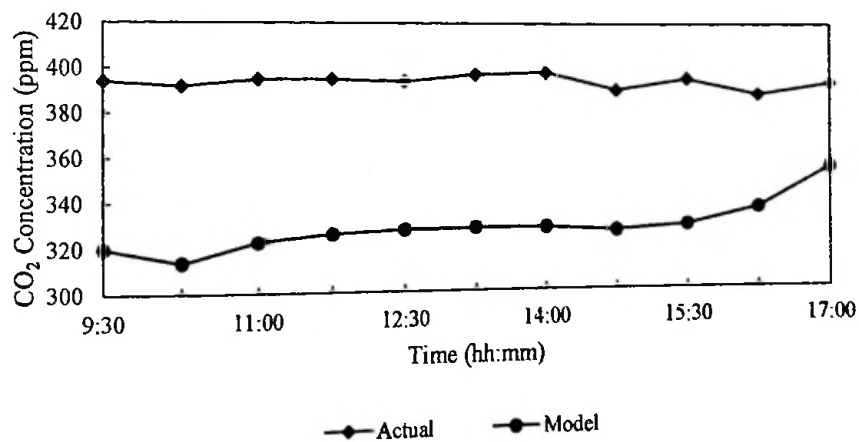

Figure 4.27: Actual CO<sub>2</sub> concentration and modelled CO<sub>2</sub> concentration at station 4

#### 4.3.5 Combinations of vegetative cover

A parametric study was carried out using the verified model in order to quantify the effects of the varying magnitude of vegetation and varying the locations of vegetation.

Since the aim of the study is to develop guidelines for residential development, the extent of the land related to this study was defined to have one third of the land as

open space. The changes were done only within this demarcated boundary. The boundary under consideration is shown in the Figure 4.28.

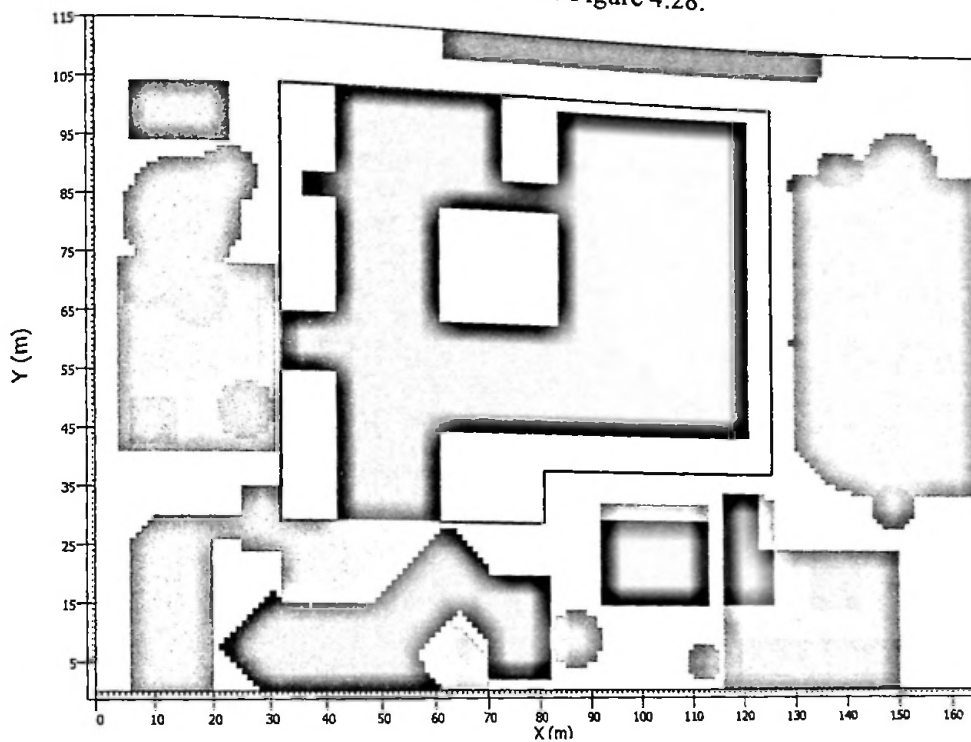

**Figure 4.28:** The demarcated boundary of the CEC (Red line)

Limited cases were identified in order to achieve various combinations. Table 4-6 shows the combinations to determine the effect of magnitude of the vegetation and the location of the vegetation. The values given in the table are the percentage of ground level vegetation out of open space requirement.

In previous studies, it has been identified the locating trees in eastern side and western side is beneficial in terms of the energy reduction for cooling load. Several cases were modelled to quantify the effect of placing vegetation in such directions in Sri Lankan residential buildings. In these combinations the shape of the building was changed accordingly.

The arrangement of the building and the vegetation of combination 2, combination 3, combination 9, and combination 10 are shown in Figure 4.29. The arrangement of the combination 4 to combination was not presented here since the vegetation arrangement is similar to combination 3.

**Table 4-6: Combinations of the vegetation introduced in the garden space**

Combination no	Aspect of study	Location of vegetation	Cement block paving (Hardscape)*	Grass*	Trees			
					3m height	5m height	10m height	20m height
1								
2			Actual scenario					
3	Extent of vegetative cover	Around the building	100%	0%	0%	0%	0%	0%
4			0%	100%	0%	0%	0%	0%
5			0%	0%	100%	0%	0%	0%
6			0%	50%	50%	0%	0%	0%
7			0%	50%	25%	25%	0%	0%
8			0%	50%	25%	0%	25%	0%
9			0%	50%	25%	0%	0%	25%
10			0%	50%	25%	0%	0%	25%

\*Vegetative and hardscape cover expressed as a percentage of open land extent (33% of the total land area)

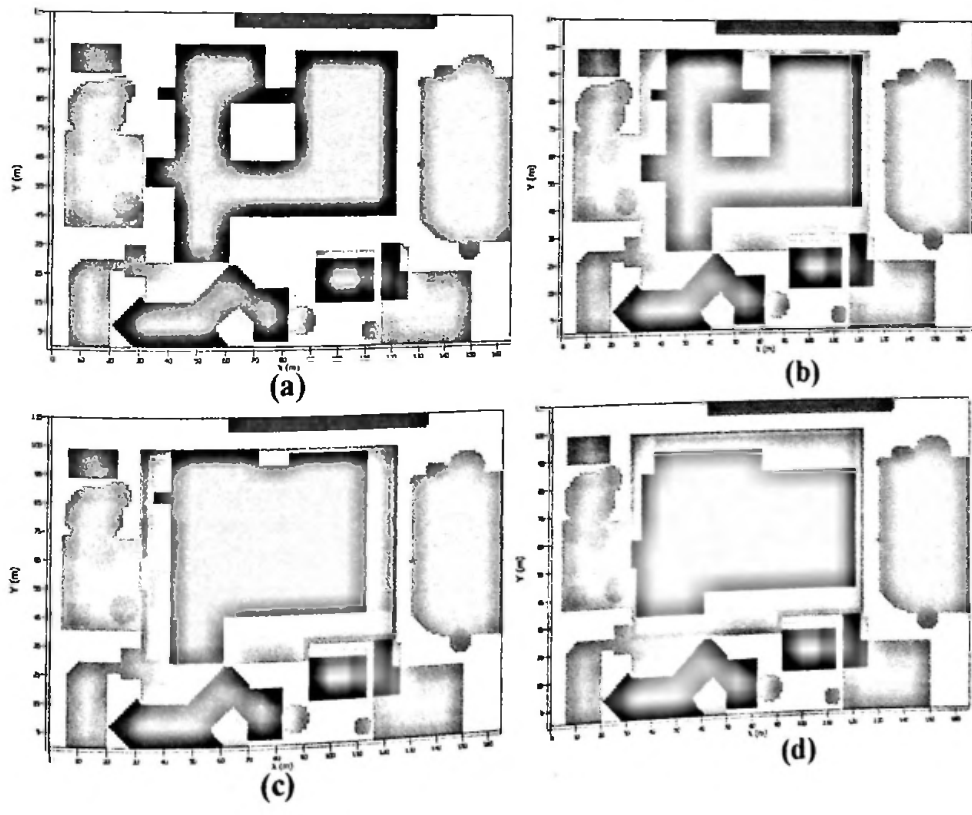

**Figure 4.29: Building and vegetation layout of defined combinations (a- Combination 2, b- Combination 3, c- Combination 9, d- Combination 10)**

#### 4.3.6 Results and discussion

ENVI-met produces a large amount of data for defined temporal and spatial resolutions. The relevant output figures for relevant cross sections are shown for discussion purposes. Several strategies that can be adopted have been discussed lately.

##### 4.3.6.1 Atmospheric temperature

The highest atmospheric temperature was recorded in the combination 2. The effect of each combination on atmospheric temperature was identified with respect to the combination 2, considering it as the base case. Equation 4-1 was used to calculate the difference of the temperature with the introduction of different levels of vegetation replacing the cement block paving.

$$\Delta T = T_b - T_{com\ i} \dots\dots\dots \text{Equation 4-1}$$

Where,

$T_b$  = Temperature of base case

$T_{com\ i}$  = Temperature of combination  $i$  (where  $i=3, 4, \dots, 10$ )

The maximum temperature has been recorded at 1:00 pm in all the cases. Thus the maximum temperature difference can be observed at 1:00 pm. The average temperature recorded in the receptors located around the building was used for the comparison for these combinations. Table 4-7 shows the temperature difference for each combination at 1 m, 5 m and 10 m height levels.

Atmospheric temperature for each case at 1 m height in the XY plane has been shown in Annex D as a 2-D profile. The interest of temperature analysis at 1 m height is taken in to consideration due to direct effects to humans and civil structures commonly having wall openings at around 1 m height.

The average temperature around the building can be reduced by 0.4 °C when cement pavements are 100% replaced by grass. With the introduction of trees in the model the maximum average reduction that was observed is 0.7°C, compared to the combination 2. Having 3m height trees in the model replacing the grass has only reduced the atmospheric temperature further by 0.1°C. An additional reduction of

0.3°C can be observed with the introduction of 5m trees in the model. Further increase of the height of the vegetation has not resulted in any further decrease of temperature at 1m level.

**Table 4-7:** The atmospheric temperature difference for different vegetation cases identified

Combination	Grass	Tree cover area % of open space at different heights				$\Delta T$ (at 1m) (°C)	$\Delta T$ (at 5m) (°C)	$\Delta T$ (at 10m) (°C)
		3m height	5m height	10m height	20m height			
3	100%	0%	0%	0%	0%	0.4	0.23	0.13
4	0%	100%	0%	0%	0%	0.5	0.23	0.23
5	50%	50%	0%	0%	0%	0.4	0.13	0.1
6	50%	25%	25%	0%	0%	0.7	0.33	0.23
7	50%	25%	0%	25%	0%	0.7	0.2	0.12
8	50%	25%	0%	0%	25%	0.7	0.44	0.24
9	50%	25%	0%	0%	25%	0.9	0.44	0.27
10	50%	25%	0%	0%	25%	1.0	0.44	0.27

Since the building height is about 12m, the 3m height tree cover shades only one third of the vertical height of the building. This has resulted in a reduction of temperature by only 0.4°C (at 1 m height) while having 5m trees has resulted in a reduction of 0.7°C. This indicates that the vegetation is effective when present at a 50% height of interested buildings. However, tree coverage beyond 50% height of interested building will not provide an additional reduction in temperature at 1 m height.



**Table 4-8:** Maximum temperature reduction at 1 m height with the reduction of vegetation at different height levels

Grass	Vegetation Cover as a percentage from open space at different height level			Temperature ( $^{\circ}\text{C}$ ) at 1m height at 13 hr	$\Delta\text{T}$ (at 1m) ( $^{\circ}\text{C}$ )
	1.5m	3m	5m		
0%	0%	0%	0%	30.5	base case
100%	0%	0%	0%	30.1	0.4
50%	50%	50%	0%	30.1	0.4
0%	100%	100%	0%	30.0	0.5
50%	50%	50%	25%	29.8	0.7

From Table 4-7 it can be seen that the removal of the courtyard has increased the thermal comfort around the building further by  $2^{\circ}\text{C}$ . No significant difference can be found in the atmospheric temperature when vegetation is placed along East-West sides compared with North-South sides of the building.

#### 4.3.6.2 Atmospheric CO<sub>2</sub> concentration

In ENVI-met no CO<sub>2</sub> generation is calculated other than the CO<sub>2</sub> generated by plants. Hence, these output figures basically indicate the CO<sub>2</sub> absorption capacity by the plants. It is well known that the CO<sub>2</sub> absorption increases with the CO<sub>2</sub> concentration. The background CO<sub>2</sub> concentration was considered as 350 ppm, the default value, for combination 2 to combination 10 in order to avoid the over estimation of CO<sub>2</sub> absorption capacities by the plants. The 2-D profiles of the atmospheric CO<sub>2</sub> concentration at the height of 1 m in XY plane is shown in Annex E.

The maximum CO<sub>2</sub> concentration has observed in the combination 2 where there is no vegetation in the land. The reduction of CO<sub>2</sub> concentration ( $\Delta C$ ) in all the other cases with respect to combination 2 can be found in Table 4-9. The relationship for  $\Delta C$  can be found in Equation 4-2.

$$\Delta C = C_b - C_{com\ i} \dots\dots\dots \text{Equation 4-2}$$

Where,

$C_b$  = Concentration of base case

$C_{com\ i}$  = Concentration of combination  $i$  (where  $i = 3, 4, \dots, 10$ )

**Table 4-9:** The reduction of atmospheric CO<sub>2</sub> concentration for different vegetation cases identified

Combination	Grass	Space defined for different height of trees at ground level as a % of open space				$\Delta C$ (at 1m) (ppm)	$\Delta C$ (at 5m) (ppm)	$\Delta C$ (at 10m) (ppm)
		3m height	5m height	10m height	20m height			
3	100%	0%	0%	0%	0%	1.3	1.5	-2.7
4	0%	100%	0%	0%	0%	5.3	3.3	4.3
5	50%	50%	0%	0%	0%	4.3	1.3	0.3
6	50%	25%	25%	0%	0%	9.3	5.3	1.3
7	50%	25%	0%	25%	25%	14.3	15.3	7.3
8	50%	25%	0%	0%	25%	17.3	15.3	7.3
9	50%	25%	0%	0%	25%	21.3	15.3	2.3
10	50%	25%	0%	0%	25%			

Replacing cement pavement with grass and trees up to 5 m height has shown a marginal reduction in CO<sub>2</sub> concentration. Trees having 10 m height and 20 m height have shown a considerable reduction of CO<sub>2</sub> concentration at 1 m height level. From the above observation it can be concluded that tree coverage exceeding the height of the building will result in an optimum reduction of CO<sub>2</sub>. This phenomenon can be due to the reduction of wind speed with the presence of impeding vegetation.

From Table 4-9 it can be observed that the CO<sub>2</sub> concentration is comparatively low when the vegetation is placed around the building without having a courtyard. A further reduction of CO<sub>2</sub> concentration by around 4 ppm can be observed with the placement of vegetation in North-South sides of the building. Thus placing the vegetation in North-South side is beneficial in reducing the atmospheric CO<sub>2</sub> concentration as well.

### 4.3.6.3 Wall temperatures

The surface wall temperatures at 2 m height for different types of vegetation arrangement are shown from Figure 4.30 to Figure 4.33. It can be seen that the temperature of the eastern wall of the building is comparatively high in the morning hours as it is directly exposed to the solar radiation having maximum of 44 °C and minimum of 20.4 °C. The maximum temperature in the eastern wall has been observed at 9.00 pm. The temperature of the western wall peaks at about 2.00 pm with a lesser peak than in the eastern wall. This can be mainly due to the shades of the dense vegetation present in the south-west direction since the sun is setting in between West and South-west direction in the month of December. The variation of northern and southern wall temperatures is fairly same with maximum values of 28.2 °C.

Several studies have been carried out to simulate the ground surface temperatures with different surface finishing materials (R. Emmanuel, Rosenlund, and Johansson 2007b; X. Yang et al. 2013). They have shown that ENVI-met is capable in predicting the ground surface temperature reasonably. However, in previous studies no attention has been paid for wall surface temperatures. The results for ground surfaces cannot be used to verify the results for wall surfaces since the ground is a horizontal material whereas the wall is a vertical element. Thus a small-scaled experimental program was carried out in order to verify the model results.

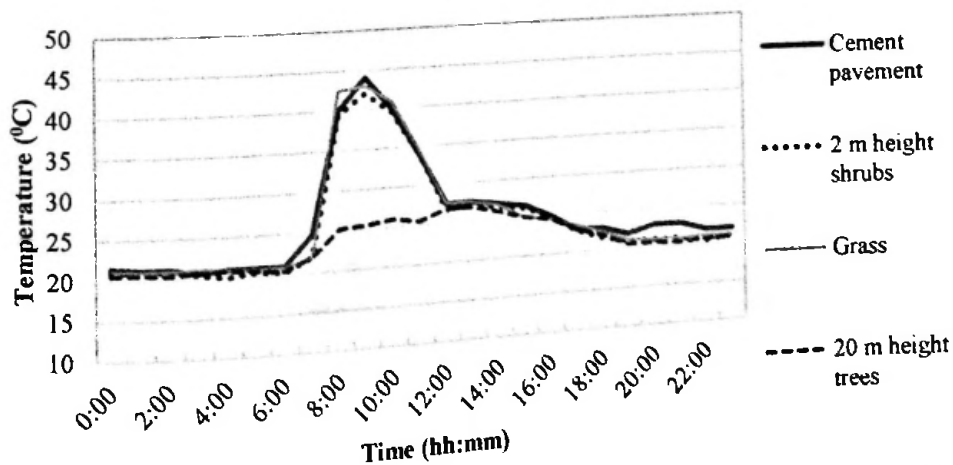

Figure 4.30: Outside surface temperature variation of the eastern wall of the building



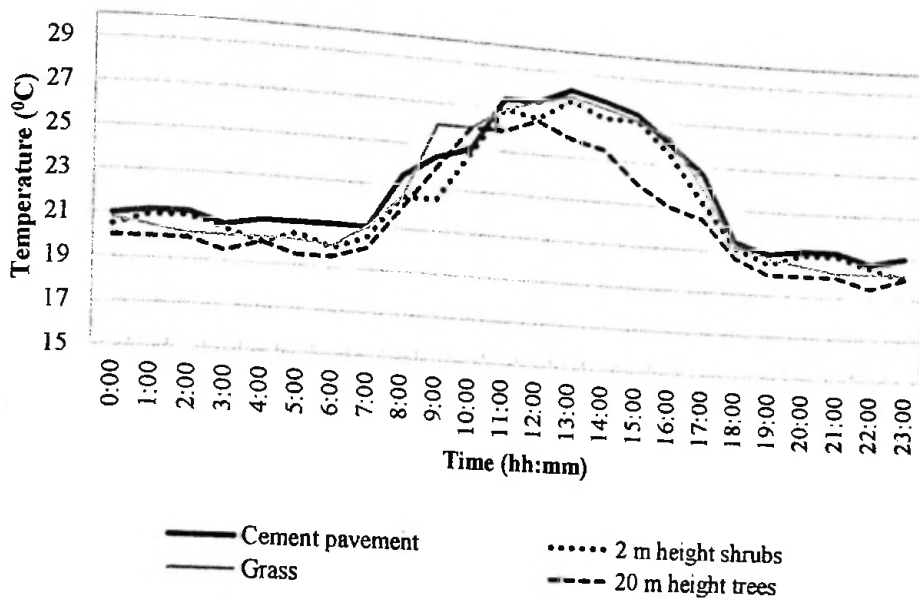

Figure 4.31: Outside surface temperature variation of the western wall of the building

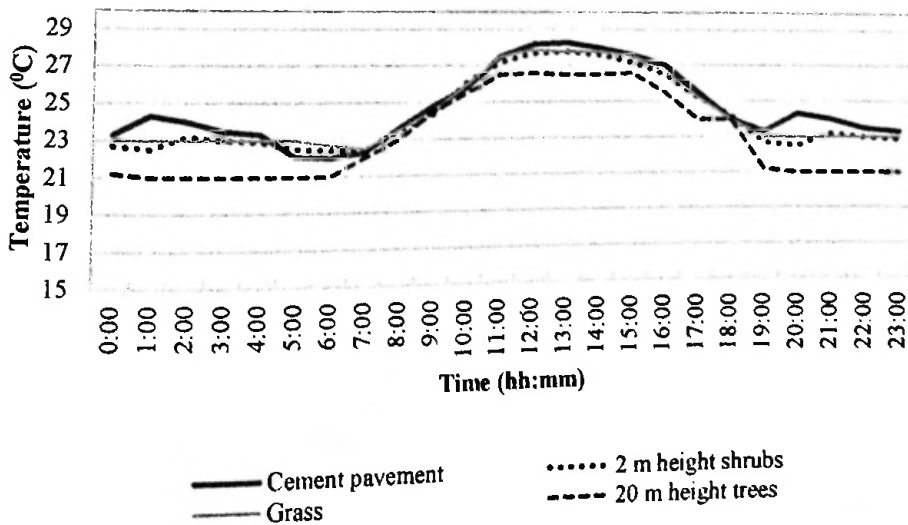

Figure 4.32: Outside surface temperature variation of the northern wall of the building

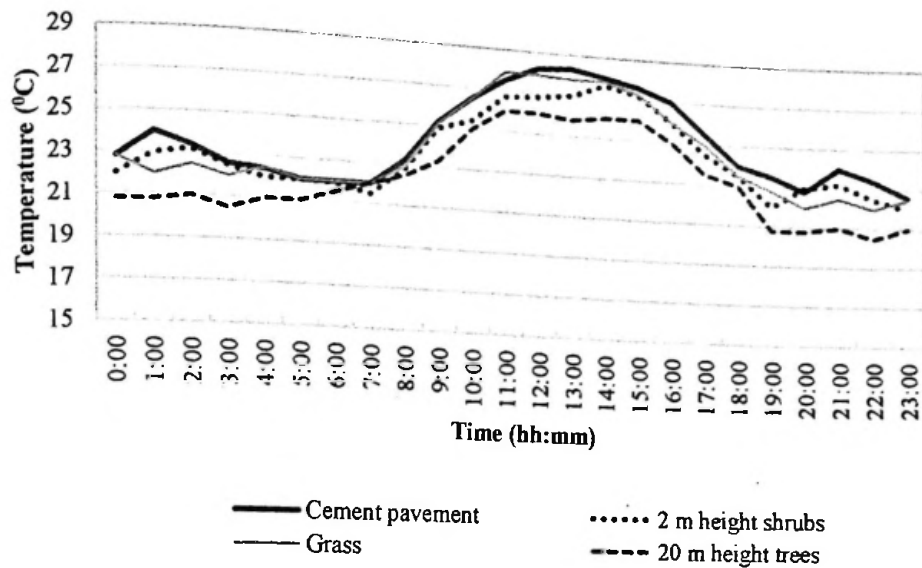

Figure 4.33: Outside surface temperature variation of the southern wall of the building

#### 4.3.6.4 Verification of the effect of vegetation on wall surface temperature

Since there is less availability of literature on wall temperature predictions from ENVI-met, an experimental study was conducted to validate the results of wall temperature. This study was designed to investigate the reduction of outer surface temperature of walls with the introduction of vegetation around the building. The study was conducted in the CEC premises in order to establish the same solar exposure condition in the experiment. The location of the experimental study comparatively to the CEC is shown in Figure 4.34.

For this experimental study, two physical models were constructed and one model unit was covered with the vegetation as shown in Figure 4.35. Three sides of the model were made out of cement blocks except the western side which was covered using plywood sheets. In both units asbestos sheets were used as the roofing material. The dimensions of the model unit are shown in Figure 4.36. The vegetation was placed around the physical model to represent the combination 5a and combination 5b.

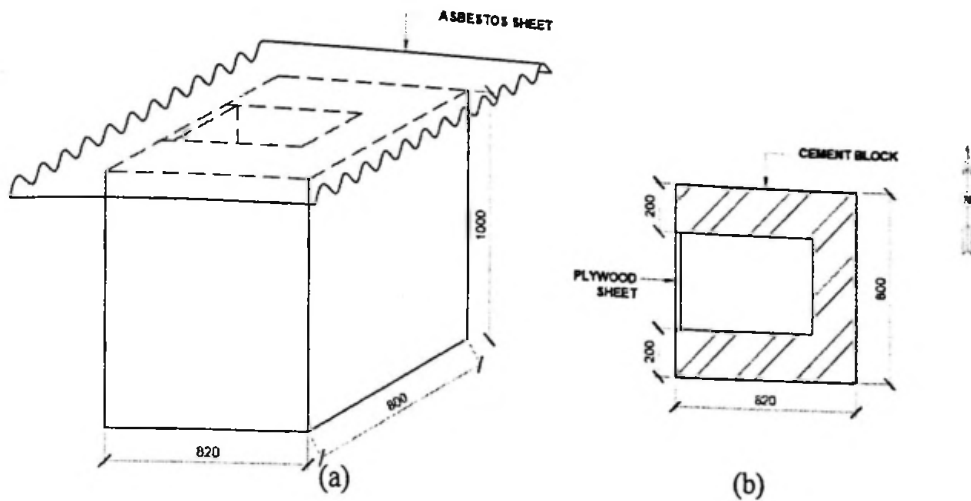

**Figure 4.34:** Location of the experimental study (Red circle)



**Figure 4.35:** Constructed physical models

The surface temperatures for 24 hours were obtained using thermo couples and a data logger which records data once in 5 minutes. The eastern and southern wall temperatures were obtained due to the higher exposure to direct solar radiation than the other sides. The thermos couples were stuck in the middle of wall panel assuming an equal distribution of temperature over the wall surface.



**Figure 4.36:** Dimensions of the physical models (a- 3D view, b- plan view)

The eastern wall surface temperatures for 24 hours are shown in Figure 4.37. The maximum eastern wall temperature has decreased by about  $5^{\circ}\text{C}$  in the experiment where the model predicts a decrease of about  $8^{\circ}\text{C}$ . An overestimation of bare surface temperature and an underestimation of surface temperature in the presence of vegetation can be observed when comparing the results. Moreover, in the experiment it can be seen that the surface has reached the maximum temperature by about 2.00 pm. However, the model predicts that the maximum surface temperature can be observed at 9.00 am.

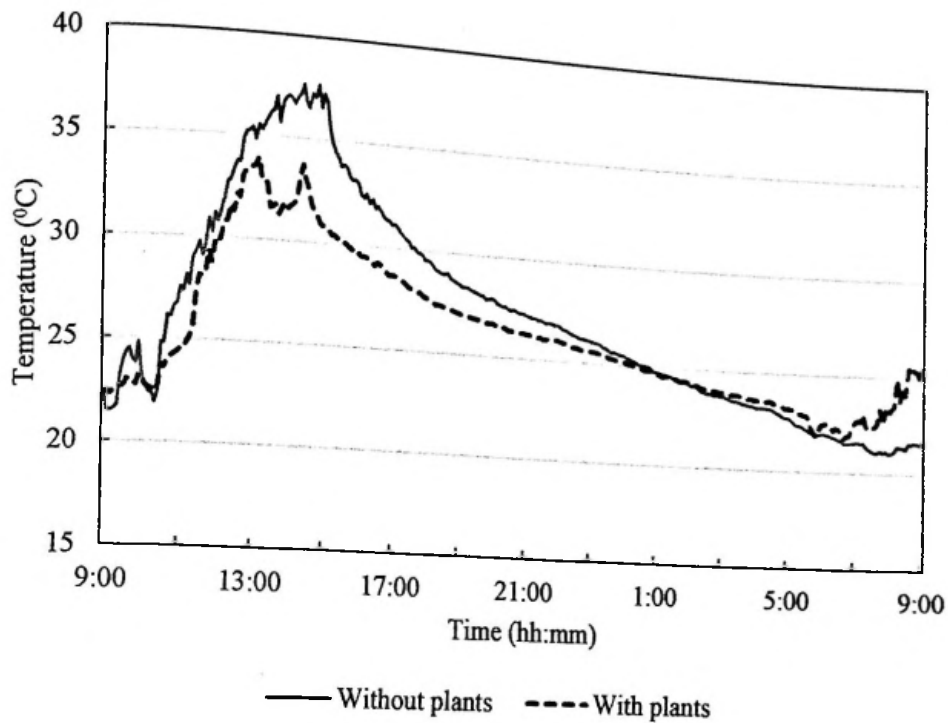

**Figure 4.37:** Variation of outer surface temperature of eastern wall

However, this variation can be linked to the exposure of the eastern wall to direct solar radiation. Unlike the ground surface parameters, ENVI-met does not require the wall parameters such as wall thickness, emissivity, specific heat etc. which is used to calculate the heat storage capacity of the wall panel. Thus it can be concluded that the predicted wall surface temperature is the instantaneous temperature of the wall which is caused by the direct solar radiation.

#### 4.4 Summary

From the experimental study, it can be concluded that the air quality in the chosen suburb in Sri Lanka is still in the acceptable range except for peaking of  $PM_{2.5}$  concentration time to time. This clearly indicates that there is a risk of exceeding the desirable air quality levels in the suburbs in near future if there is no proper plan to manage these residential developments. Based on the findings of this study, it can be suggested to have a vegetative cover around the buildings to overcome this problem since there is a favourable impact of vegetation on temperature and several air pollutant concentrations. A reasonable distance from the main road can be proposed with due consideration for the *building line* and the *street line* for the improved air quality. This can be further enhanced with a significant tree cover which could act as a barrier for the pollutants generated by the traffic. The quantification of such effect should be carried out by further investigations.

The parametric study suggests that the use of cement pavement in the vicinity is increasing the local atmospheric temperature. Thus the cement pavement should be avoided in micro-climate designing. Better outdoor micro-climates can be achieved with the introduction of vegetation. For residential buildings with a given height the effectiveness of vegetation is independent of density of vegetation, when vegetation is below one-third of the height of the building. For vegetation higher than one-half of the height of the building, a considerable effect can be observed in temperature and  $CO_2$  concentration reduction.

It also suggests that having vegetation in the northern side and southern side of the building will have a higher impact in reducing the atmospheric  $CO_2$  concentration. However, the effect on wall temperature is comparatively low. Conversely, locating the vegetation in eastern and western sides of the building has prevented the rising up of the eastern wall temperature considerably. The effect of this arrangement on atmospheric temperature and  $CO_2$  concentration is marginally less than that of placing vegetation on northern and western side. Thus it can be concluded that placing the vegetation in western and eastern sides of the building will be highly beneficial in the terms of indoor environment.

Another notable observation of this study is that the effect of ground level vegetation diminishes with the elevation. At 10 m height the effect of vegetation is fairly minimal. Thus these arrangements can be suggested only in the suburban residential developments. For urban high-rises the applicability of vertical greenery should be investigated.

## CHAPTER 5

### 5 VERTICAL PROFILES OF AIR POLLUTANTS FOR VERTICAL GREENERY

Vertical greening is a highly discussed topic worldwide with the emergence of high rises. In order to introduce such systems effectively, the vertical profiles of the environmental quality parameters are needed to be investigated. This chapter presents such a study carried out in Colombo city limits.

#### 5.1 Introduction

In the present day context global urbanization is a growing concern and according to United Nation (UN) records it would be 85% in next forty years in the developing countries. The UN predicts that in Sri Lanka, urban population would grow by 116% in the next forty years (*World Urbanization Prospects*, n.d.). In order to accommodate the increasing population and related economic activities more and more high-rise buildings would be constructed. Thus the layout of the cities has been converting rapidly to street canyons with multi storey buildings and high-rises along the sides of the streets. This layout creates deeper street canyons with low wind speeds which reduces the air movement inside the city. Studies done in Colombo and Hong Kong show, lower wind speed in deeper canyons than in shallow canyons (Yuan and Ng 2012; Rohinton Emmanuel and Johansson 2006). This causes vehicular emissions to be stagnant near the ground level of the streets.

Conversely, the vegetation is also present at the ground level with the maximum height of 20 – 25 m. This vegetation can act as air pollutant sink sources. Thus the vertical dispersion of air pollutants near the ground level can be complex due to the interaction of emission sources and sinks. Furthermore, in the Chapter 4 it has been shown that the effect of ground level vegetation reduces with the height. Similarly, the air pollutant concentration also can be reduced with the height depending on their molecular weight. Hence a thorough knowledge is required in proposing vertical greening systems for high rises.

A series of experimental studies was carried out in two multi storeyed buildings in order to investigate the vertical profiles of several air quality parameters and identify the possible causes for such variations.

## 5.2 Experimental Study

The city of Colombo being the main commercial city in Sri Lanka is vulnerable to rapid intensification of multi storey buildings including high rises. Moreover the fast urbanization attracts more vehicular traffic into the city creating highly congested roads which in turn results in a polluted environment in the city. Thus two multi storeyed buildings termed as B1 and B2 which are located in Colombo vicinity were selected for this study. The study locations can be found in Figure 5.1.

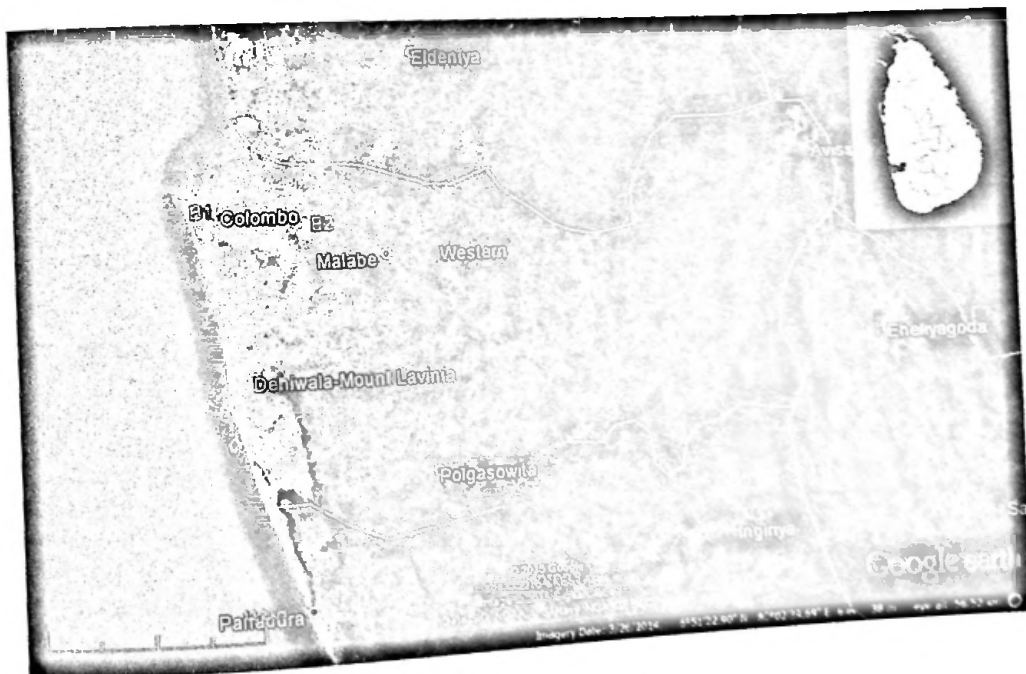
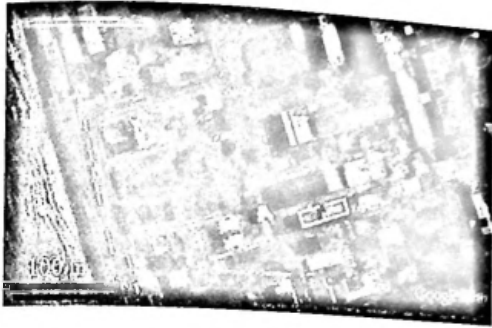

Figure 5.1: Study location

Eventhough, both B1 and B2 are located in the Colombo metropolitan region the outdoor micro-climatic features are considerably different. The satellite image shown in Figure 5.2 reveals that B1 is surrounded by higher amount of hardscape features than B2.



(a)



(b)

**Figure 5.2:** Satellite images of the vicinity of the selected buildings (a-B1, b-B2)

### 5.2.1 Site description

The first building (B1) is an office building located along a “A” class road, named as Galle road which is having a high density of urban traffic about 70,000 AADT. The first seven storeys in the eight storeyed building are utilized as office area and the entire seventh floor is utilized as the cafeteria. Each office floor comprises of two wings; East wing and West wing and central lobby and service area. The whole building is mechanically ventilated using split type air conditioners except the lobby area and the seventh floor. The layout of the building has been shown in Figure 5.3. Lobby area and the seventh floor are exposed to the outdoor environment and it is naturally ventilated.

The second building (B2) is an apartment building which is located near a “B” class road with an AADT of about 10,000. The building comprises of 20 storeys having two wings and a central lobby except the lower most floor and two upper most floors. The typical layout of the building is shown in Figure 5.4. The ground floor has been utilized as a car park and the two upper most floors have been used as a single apartment unit. The lobby area is naturally ventilated where the apartment blocks are mechanically ventilated.



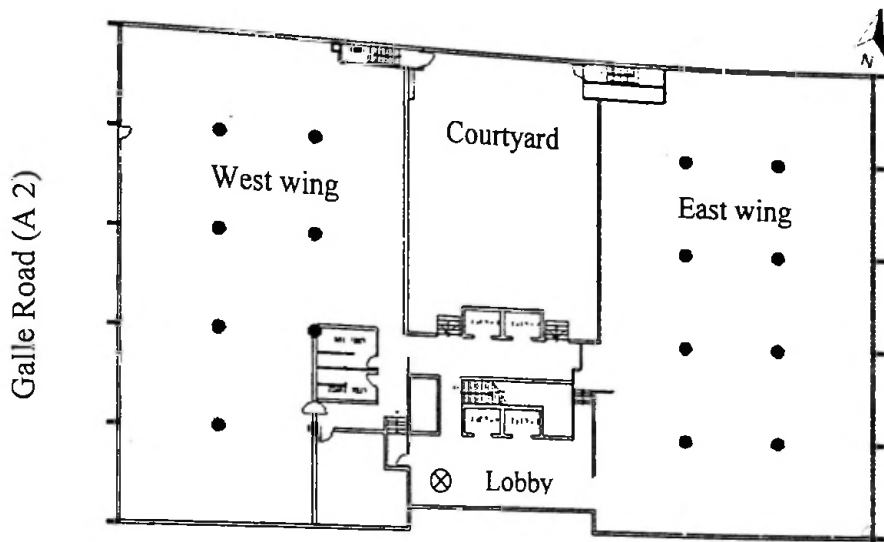

⊗ - Location of the measurement

Figure 5.3: The layout of the building (B1)

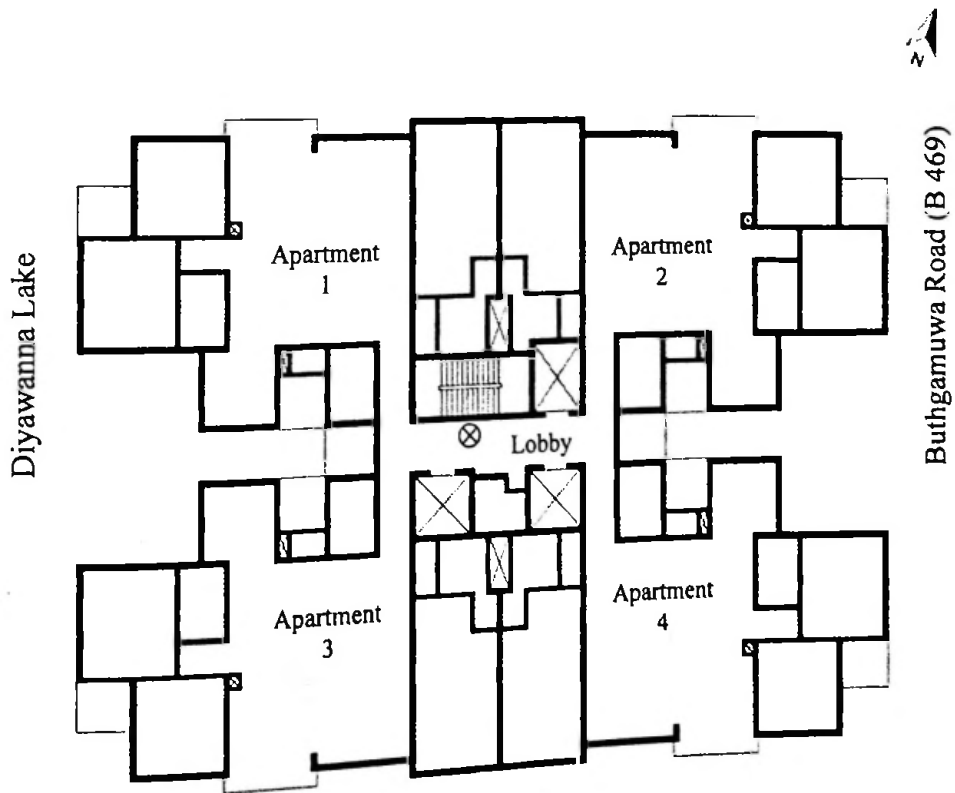

⊗ - Location of the measurement

Figure 5.4: The layout of the building (B2)

The experiment was carried out in naturally ventilated lobby in both buildings in order to obtain the vertical profiles of the air quality parameters. In B1 data was collected for each and every floor and in B2 data was collected from five intermittent floors.

### **5.2.2 Data collection**

In order to assess the indoor environment of the free running spaces in the buildings, a set of pollutants was measured. Several air quality parameters were measured such as CO<sub>2</sub>, NO<sub>2</sub> and PM<sub>2.5</sub>. In this study the main source of CO<sub>2</sub> generation was the occupants with some contribution from vehicular traffic whereas the main source of NO<sub>2</sub> and PM<sub>2.5</sub> emission was the vehicular traffic. Temperature, relative humidity and the wind speed were also monitored to assess the thermal comfort.

Measurement of PM<sub>2.5</sub> concentration was carried out using Haz-Dust EPAM 5000 a real-time particulate monitor designed for ambient environmental and indoor air quality applications. Other air quality parameters were measured by IQM 60 which is integrated with photo-ionization detector (PID) and non-dispersive infra-red (NDIR) sensors.

Concentration of each location was obtained averaging the data over a period of 30 minutes, measured with 2 minutes interval for CO<sub>2</sub>, NO<sub>2</sub> whereas PM<sub>2.5</sub> concentrations were obtained averaging the data over a 30 minutes period, measured with 1 minute intervals. All the readings were obtained from 8.00 am to 4.00 pm representing the diurnal condition inside the building. The experiment was conducted for 2 days in the B2.

## **5.3 Results and Analysis**

The averaged concentration values were plotted against the floor levels to obtain the vertical profiles of the pollutants. The vertical profiles of different air pollutants are discussed in the following sections.

### **5.3.1 Vertical profile NO<sub>2</sub> concentration**

Vertical profiles of the averaged NO<sub>2</sub> in B1 and B2 are shown in Figure 5.5 and Figure 5.6 respectively. As shown in the Figure 5.5, NO<sub>2</sub> concentration for B1 seems

to be reduced with the floor height having the maximum  $\text{NO}_2$  concentration in the ground floor. However, in B1 the variation curve obtained by the experimental results does not show a proper correlation, a decreasing trend of  $\text{NO}_2$  concentration can be observed with the increasing floor height.

Conversely, in B2 no such trend can be observed as shown in Figure 5.6. It can be seen that the average concentration in day 1 is less than the average concentration in day 2. The data collection in B2 was carried out in a corridor, having two openings facing the Diyawannawa Lake and the Buthgamuwa Road as shown in Figure 5.4. It was recorded that in day 1 the wind blew from the side of the Diyawanna lake and in day 2 the wind blew from Buthgamuwa road throughout the day. The possible cause for the different behaviour patterns can be due to the orientation of opening to different micro-climatic features.

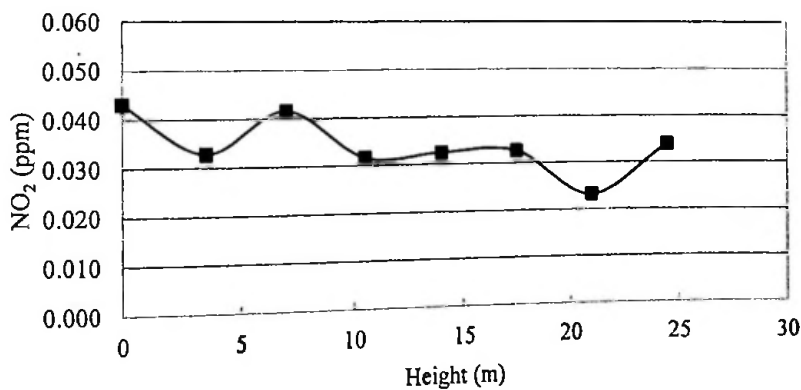

Figure 5.5: Vertical profile of  $\text{NO}_2$  concentration in B1

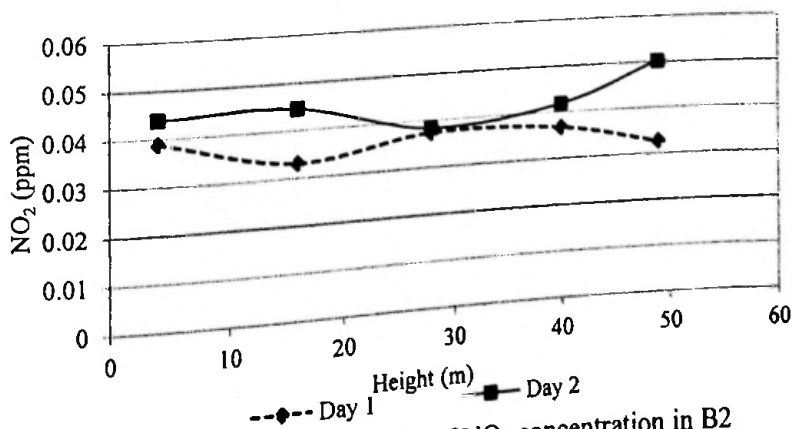

Figure 5.6: Vertical profile of  $\text{NO}_2$  concentration in B2

### 5.3.2 Vertical profile CO<sub>2</sub> concentration

An increasing trend of CO<sub>2</sub> concentration with the floor height can be seen in the free running space of B1 according to the Figure 5.7. It shows lower CO<sub>2</sub> concentration up to 7 m (first three floor levels) averaging 313 ppm, while in the next four floor levels averaging 440 ppm. Lower CO<sub>2</sub> level in the first three floors can be explained by the presence of a tree crown up to the 1<sup>st</sup> floor level at the front of the lobby area.

Figure 5.8 shows the vertical profile of CO<sub>2</sub> concentration in the B2. Unlike in B1, a constant level of CO<sub>2</sub> concentration has been recorded with the varying height. A lesser value has been recorded in day 1 compared to day 2 for CO<sub>2</sub> concentration as well. This also can be explained by the wind-blowing from the Diyawanna Lake.

The CO<sub>2</sub> concentration in B2 is lower than the CO<sub>2</sub> concentration in B1 on average. This can be attributed to having a water body and vegetation in the vicinity of the B2.

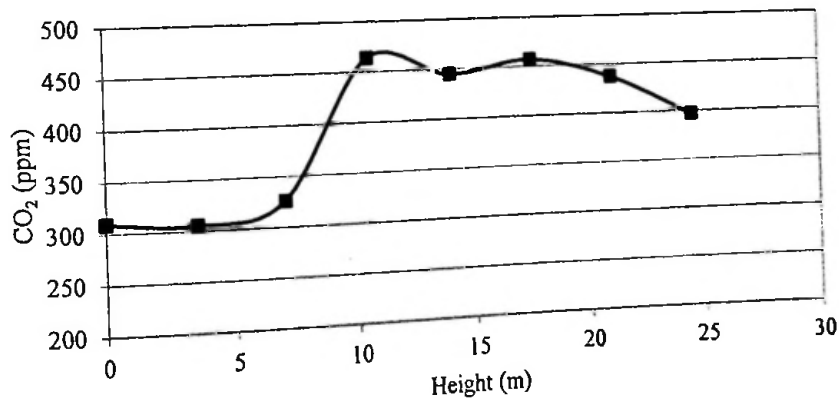

Figure 5.7: Vertical profile of CO<sub>2</sub> concentration in B1

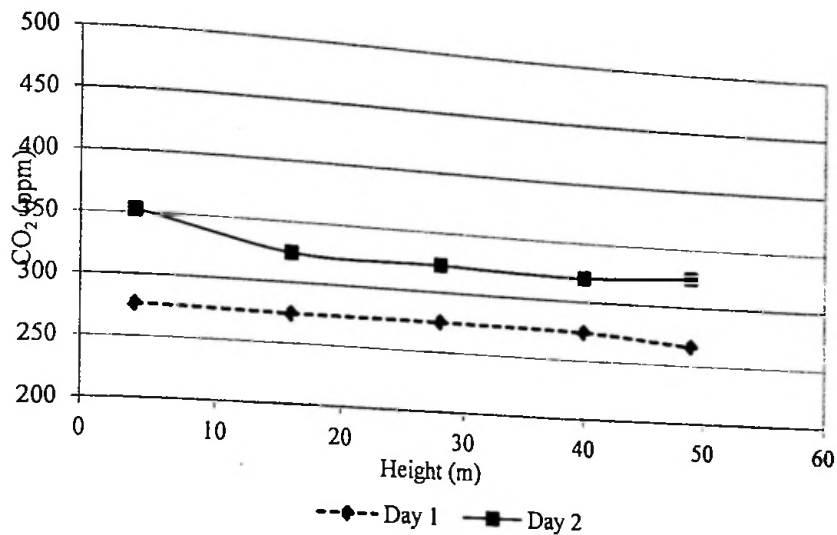

Figure 5.8: Vertical profile of CO<sub>2</sub> concentration in B2

### 5.3.3 Vertical profile PM<sub>2.5</sub> concentration

The vertical profile of the PM<sub>2.5</sub> concentration in B1 is shown in Figure 5.9. It shows a fluctuating variation up to 2<sup>nd</sup> floor, followed by a smooth declining variation upwards. The significance of the variation is the peak concentration at 7 m height and the gradual decrease in concentration with the floor height after the peak concentration.

Figure 5.10 shows the variation of PM<sub>2.5</sub> concentration with the height in B2 for day 1 and day 2. A same variation of PM<sub>2.5</sub> concentration can be seen in both days having a maximum concentration at 16 m height. The concentration in day 1 is lesser than the concentration in day 2 which can be again attributed to the presence of favourable micro-climatic features. A slight declining trend can also be seen in the results as in the B1.

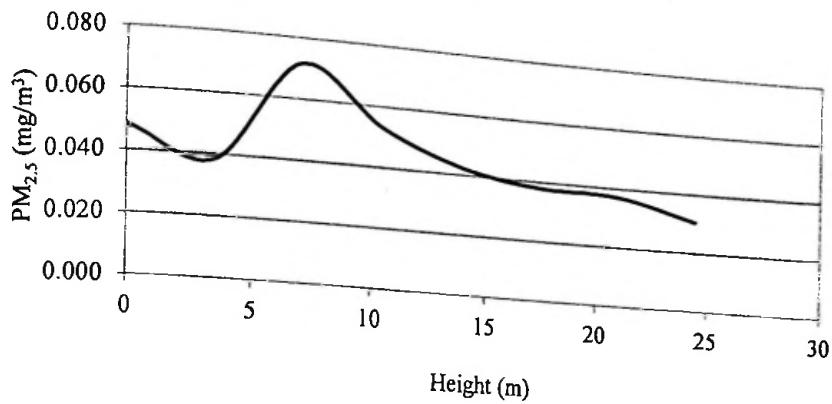

Figure 5.9: Vertical profile of PM<sub>2.5</sub> concentration in B1

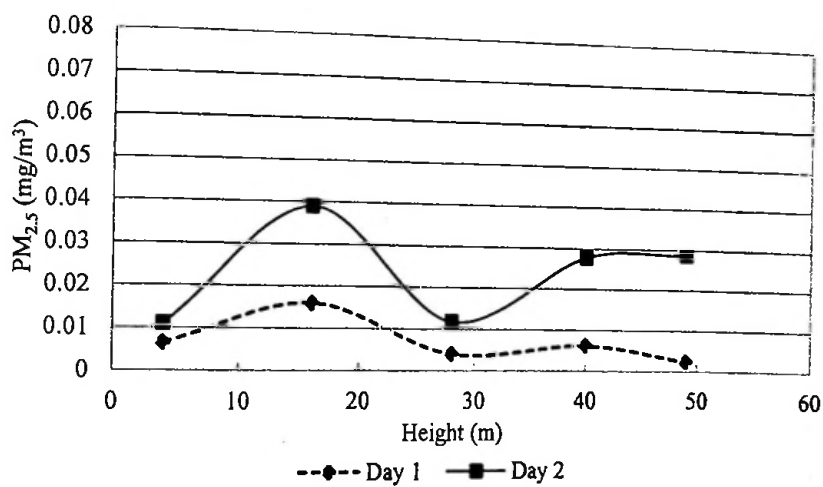

Figure 5.10: Vertical profile of PM<sub>2.5</sub> concentration in B2

#### 5.4 Factors Affecting the Vertical Profile of Air Pollutants

It can be seen that the vertical profiles of air pollutant have local variations depending on the surrounding micro-climate. The air pollutant levels in B2 which is surrounded by a water body and vegetation is lesser compared to the B1 which is a part of a street canyon. In the results for B2, it was identified that the presence of a water body near the building is favorable in terms of air quality.

In B1, the effect of vegetation can be seen only up to about 10 m height (3<sup>rd</sup> floor level) where in B2 the effect can be seen up to about 50 m height. The possible cause for this observation can be the magnitude of the favorable micro-climatic effects present in the vicinity. Moreover, it has to be considered that B1 is located in a street canyon where the wind speed around the building is lower compared to B2. It can be

seen that the vertical dispersion of air pollutants is prominent than horizontal dispersion. Thus it can be concluded that vertical greenery is highly beneficial for high-rises in the middle of dense development.

From this it can be concluded that these factors should be considered when proposing a vertical greenery system for a multi-storied building. A proper investigation for vertical dispersion of air quality level must be carried out since the vertical profiles are having the local validity.

## CHAPTER 6

### 6 CONCLUSIONS

In this thesis, a work carried out to investigate the incorporation of vegetation in built-environment has been explained. Several conclusions can be made which will assist building planners to design better indoor and outdoor micro-climates.

1. Out of the two plants used in the study Table palm has the highest performance in absorbing CO<sub>2</sub>. This plant can be identified as one of the best indoor plants as this is commonly available and the cost of plant is in the lowest range. The cost of this plant is only one third of the other plant; Pleomele. Moreover, this plant can be easily maintained because of its' less water requirement and pruning requirement.
2. It can be concluded that the Pleomele plant can be used more effectively to act as a barrier for VOC dispersion. The main reason for this observation can be the structural difference between the two plants. The Table palm is having a few number of horizontally spread large leaves where Pleomele plant is having higher number of vertically aligned small leaves.
3. Among the indoor lighting combinations, the sunlight provides the maximum PAR level. Thus placing plants near windows to have maximum sunlight will be beneficial in reducing the indoor CO<sub>2</sub> levels. The plants can be kept around the indoor stationary VOC sources such as photocopiers and printers, since plants can act as a barrier to VOC dispersion.
4. From the opinion survey it can be concluded that there is a considerable public preference to have indoor plants. The public found it to be visually pleasing to have indoor plants.
5. A possible risk of exceeding the threshold levels of air pollutant in outdoor has been found in suburban area unless a proper development management plan would be introduced. It can be suggested to have vegetation cover around the buildings due to its favorable effect on temperature and air quality.
6. Cement pavements must be avoided in residential developments in order to create better outdoor micro-climates which in turn favorably affects the indoor environment.



7. For residential buildings with a given height the effectiveness of vegetation is independent of density of vegetation, when vegetation is below one-third of the height of the building. For vegetation higher than one-half of the height of the building, a considerable effect can be observed in temperature and CO<sub>2</sub> concentration reduction.
8. Locating vegetation in northern and southern sides provides the maximum effect on atmospheric temperature. Locating vegetation in eastern and western side reduces the wall temperatures significantly. The difference in atmospheric temperature and CO<sub>2</sub> concentration between locating vegetation in eastern-western sides and northern-southern sides is marginal. Thus locating vegetation in eastern-western sides may provide the maximum effect on energy demand for indoor thermal comfort and air quality.
9. The effect of ground level vegetation diminishes beyond a certain height of a building around 10 m. This is the height of a three storied building. Thus vertical greenery should be adopted in high-rises. The effect of the air pollutant source also diminishes with the elevation. Thus the vertical profiles of air pollutants can be considered as a factor affecting the vertical greenery systems.
10. The vertical air profiles are having local validity due to the varying wind speed, wind direction, micro-climatic features, and the geometry of the surrounding built-environment. A stagnation of air pollutants near ground levels can be found in the building located in street canyons. The reduced wind speed due to less porosity of such environment and reduced horizontal movement of air pollutants have caused this problem. The ground level vegetation has negligible impact or adverse impact in such conditions. Hence, the having of vertical greenery can be considered as the most effective method for high-rises in incorporating the vegetation in built-environment.
11. The water bodies also have found to be a favorable feature in creating better micro-climates. Placing the openings in the building to capture more wind blown over water bodies will results in better indoor air quality.
12. A reasonable distance from the main road also can be proposed with due consideration for the *building line* and the *street line* as another strategy in having better air quality.

13. The parametric study based on computer simulation which was validated using field data is one of the most reliable methods in proposing building designing and planning guidelines.

## 6.1 Recommendations

The following recommendations can be made on the incorporation of indoor plants:

1. It is proposed to use "Table palm" as a species for indoor plants due to its more favorable results.
2. Placing plants close to a window is preferred since it can attract higher amount of sunlight for photosynthesis.
3. An approximate guideline can be devised for the leaf area density needed for a significant reduction of CO<sub>2</sub> concentration inside in activity spaces. This depends on the species as well. However, coverage of 5-10% of the floor area can be considered as a guideline and this may vary with dense plants such as Pleomele.
4. Since night time emission was detected in both experiments, the indoor plants would be an ideal solution for the office spaces and commercial buildings where the occupancy is limited to the daytime.

The following recommendations can be made with respect to outdoor micro-climate.

1. Since hardscape in the garden such as cement block paving or asphalt paving increases the surrounding temperature and also does not give any favourable effect on reducing levels of pollution, the area of paving should be kept to a minimum.
2. It is recommended to replace the cement block paving with grass where possible and areas like driveways can be made out of stabilized earth with a pebble seal which is having albedo of 0.3 and solar absorptivity of 0.5.
3. For residential buildings it is recommended to have a tree cover of at least the half the height of the building in the garden space created with 66% plot coverage.

4. Since the tree cover at higher elevation shows favourable results in terms of thermal comfort and air quality it is suggested to have tall trees at a reasonable distance from the building.
5. Even in multi-storey buildings where large trees cannot be placed due to practical reasons, a micro-climate with a considerable tree cover can be created at the balconies at each level. This can be incorporated in the building design as shown in the example indicated in Figure 6.1.

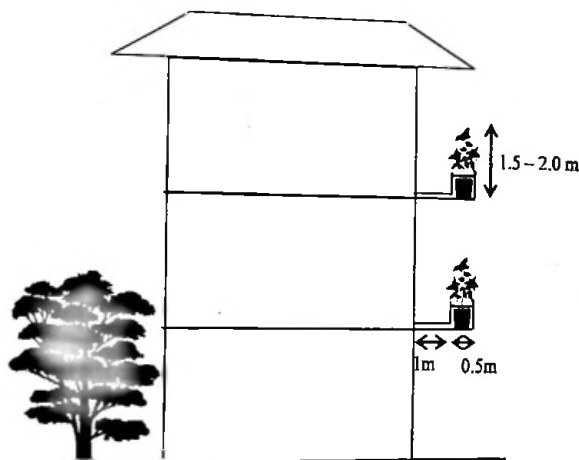

**Figure 6.1:** An arrangement for vertical greenery

This feature has to be incorporated together with the concepts of building orientation. (i.e. Western side of the building can be shaded with trees in the vertical direction of the multi-storeyed buildings.)

## 6.2 Future work

Future research works that can be carried based on the findings of this research are;

1. Development of a database of indoor plants having higher potential in purifying indoor environment
2. Identification of most suitable window orientation in order to have maximum effect of sunlight for indoor plants considering glare and thermal radiation penetrates in to building
3. Investigation on technical feasibility of internal green facades

4. Identification of visually pleasing indoor plants that can be kept in office environment to reduce sick building syndrome
5. Investigation and quantification of the effect of vegetation on outdoor micro-climate in different macro-climates
6. Sensitivity analysis of the effects of reduction in atmospheric temperature, CO<sub>2</sub> concentration, and wall surface temperature on energy demand for indoor thermal comfort and air quality
7. Identification of the effect of water bodies in creating better outdoor micro-climates
8. Investigation on the barrier effect of outdoor vegetation to filter the road side air streams which contain a higher level of air pollutants

## 7 REFERENCES

- Apte, Michael G., W. J. Fisk, and Joan M. Daisey. 2000. "Associations between Indoor CO<sub>2</sub> Concentration and Sick Building Syndrome Symptoms in US Office Buildings: An Analysis of 1994-1996 Base Study Data." *Indoor Air* 10: 246-57.
- Béland, Martin, Jean-Luc Widlowski, Richard A. Fournier, Jean-François Côté, and Michel M. Verstraete. 2011. "Estimating Leaf Area Distribution in Savanna Trees from Terrestrial LiDAR Measurements." *Agricultural and Forest Meteorology* 151 (9): 1252-66.
- Bischof, Walter. 1962. "Variations in Concentration of Carbon Dioxide in the free atmosphere1." *Tellus* 14 (1): 87-90.
- Bluyssen, Philomena M., Myriam Aries, and Paula van Dommelen. 2011. "Comfort of Workers in Office Buildings: The European HOPE Project." *Building and Environment* 46 (1): 280-88.
- Bohning, R. H., and Christel A. Burnside. 1956. "The Effect of Light Intensity on Rate of Apparent Photosynthesis in Leaves of Sun and Shade Plants." *American Journal of Botany*, 557-61.
- Boukhabl, Moufida, and Djamel Alkam. 2012. "Impact of Vegetation on Thermal Conditions Outside, Thermal Modelling of Urban Microclimate, Case Study: The Street of the Republic, Biskra." *Energy Procedia* 18: 73-84.
- Breda, N. J. J. 2003. "Ground-Based Measurements of Leaf Area Index: A Review of Methods, Instruments and Current Controversies." *Journal of Experimental Botany* 54 (392): 2403-17.
- Bringslimark, Tina, Terry Hartig, and Grete G. Patil. 2009. "The Psychological Benefits of Indoor Plants: A Critical Review of the Experimental Literature." *Journal of Environmental Psychology* 29 (4): 422-33.
- Burchett, Margaret, Fraser Torpy, and J. Brennan. 2009. "Towards Improving Indoor Air Quality with Pot-plants; A Multifactorial Investigation."
- Ca, VT, T Asaeda, and EM Abu. 1998. "Reductions in Air Conditioning Energy Caused by a Nearby Park." *Energy and Buildings* 29: 83-92.

- Cheng, C. Y., Ken K. S. Cheung, and L. M. Chu. 2010. "Thermal Performance of a Vegetated Cladding System on Facade Walls." *Building and Environment* 45 (8): 1779-87.
- Costa Rasia, Francisco Bemquerer, and Eduardo Leite Krüger. 2010. "A Method for Simulating NO<sub>x</sub> Dispersion in an Urban Area Using ENVI-Met." In *Proceedings of the 2010 Spring Simulation Multiconference*, 188:1-188:8.SpringSim '10. San Diego, CA, USA: Society for Computer Simulation International.
- Dimoudi, Argiro, and Marialena Nikolopoulou. 2003. "Vegetation in the Urban Environment: Microclimatic Analysis and Benefits." *Energy and Buildings*, Special issue on urban research, 35 (1): 69-76.
- Emmanuel, R, and Hjs Fernando. 2007. "Urban Heat Islands in Humid and Arid Climates: Role of Urban Form and Thermal Properties in Colombo, Sri Lanka and Phoenix, USA." *Climate Research* 34 (September): 241-51.
- Emmanuel, R. 2005. "Thermal Comfort Implications of Urbanization in a Warm-Humid City: The Colombo Metropolitan Region (CMR), Sri Lanka." *Building and Environment* 40 (12): 1591-1601.
- Emmanuel, R., H. Rosenlund, and E. Johansson. 2007a. "Urban Shading-a Design Option for the Tropics? A Study in Colombo, Sri Lanka." *International Journal of Climatology* 27 (14): 1995-2004.
- Emmanuel, Rohinton, and Erik Johansson. 2006. "Influence of Urban Morphology and Sea Breeze on Hot Humid Microclimate: The Case of Colombo, Sri Lanka." *Climate Research* 30 (3): 189-200.
- Fahmy, Mohamad, S. Sharples, and A. Eltrapolsi. 2009. "Dual Stage Simulations to Study the Microclimatic Effects of Trees on Thermal Comfort in a Residential Building, Cairo, Egypt." In *11th International IBPSA Conference. Glasgow, Scotland*.
- Fisk, W. J., P. Price, D. Faulkner, D. Sullivan, D. Dibartolomeo, C. Federspiel, G. Liu, and M. Lahiff. 2002. "Worker Performance and Ventilation: Analyses of Time-Series Data for a Group of Call-Center Workers." *Proceedings, Indoor Air*.

- Fjeld, Tove, and Charite Bonnevie. 2002. *The Effect of Plants and Artificial Day-Light on the Well Being and the Health of Office Workers, School Children and Health Care Personnel*. Floriade.
- Foucher, P. Y., A. Chédin, R. Armante, C. Boone, C. Crevoisier, and P. Bernath. 2011. "Carbon Dioxide Atmospheric Vertical Profiles Retrieved from Space Observation Using ACE-FTS Solar Occultation Instrument." *Atmospheric Chemistry and Physics* 11 (6): 2455-70.
- Fujii, Shuji, Hiun Cha, Naoki Kagi, Hisashi Miyamura, and Yong-Shik Kim. 2005. "Effects on Air Pollutant Removal by Plant Absorption and Adsorption." *Building and Environment* 40 (1): 105-12.
- Garrity, Steven R., Kevin Meyer, Kyle D. Maurer, Brady Hardiman, and Gil Bohrer. 2012. "Estimating Plot-Level Tree Structure in a Deciduous Forest by Combining Allometric Equations, Spatial Wavelet Analysis and Airborne LiDAR." *Remote Sensing Letters* 3 (5): 443-51.
- Georgi, N. J., and K. Zafiriadis. 2006. "The Impact of Park Trees on Microclimate in Urban Areas." *Urban Ecosystems* 9 (3): 195-209.
- Georgieva, Elka, Nedjalka Handjieva, Simeon Popov, and Luba Evstatieva. 2005. "Comparative Analysis of the Volatiles from Flowers and Leaves of Three Gentiana Species." *Biochemical Systematics and Ecology* 33 (9): 938-47.
- Giridharan, R., S.S.Y. Lau, S. Ganesan, and B. Givoni. 2008. "Lowering the Outdoor Temperature in High-Rise High-Density Residential Developments of Coastal Hong Kong: The Vegetation Influence." *Building and Environment* 43 (10): 1583-95.
- Gratani, Loretta, and Laura Varone. 2007a. "Plant Crown Traits and Carbon Sequestration Capability by *Platanus Hybrid* Brot. in Rome." *Landscape and Urban Planning* 81 (4): 282-86.
- Green, Laura C, and Sarah R Armstrong. 2003. "Particulate Matter in Ambient Air and Mortality: Toxicologic Perspectives." *Regulatory Toxicology and Pharmacology* 38 (3): 326-35.
- Gupta, Sanjeev, Mukesh Khare, and Radha Goyal. 2007a. "Sick Building syndrome—A Case Study in a Multistory Centrally Air-Conditioned Building in the Delhi City." *Building and Environment* 42 (8): 2797-2809.



- Hakola, Hannele, Janne Rinne, and Tuomas Laurila. 1998. "The Hydrocarbon Emission Rates of Tea-Leafed Willow (*Salix Phylicifolia*), Silver Birch (*Betula Pendula*) and European Aspen (*Populus Tremula*)." *Atmospheric Environment* 32 (10): 1825-33.
- Hansen, J., R. Ruedy, M. Sato, M. Imhoff, W. Lawrence, D. Easterling, T. Peterson, and T. Karl. 2001. "A Closer Look at United States and Global Surface Temperature Change." *Journal of Geophysical Research: Atmospheres* 106 (D20): 23947-63.
- Hansen, Matthew C., Stephen V. Stehman, and Peter V. Potapov. 2010. "Quantification of Global Gross Forest Cover Loss." *Proceedings of the National Academy of Sciences* 107 (19): 8650-55.
- Hill, A. Clyde. 1971. "Vegetation: A Sink for Atmospheric Pollutants." *Journal of the Air Pollution Control Association* 21 (6): 341-46.
- Hosoi, F., and K. Omasa. 2009. "Estimating Vertical Leaf Area Density Profile of Tree Canopies Using Three-Dimensional Portable LiDAR Imaging." In *Proceedings of the ISPRS Workshop Laser-Scanning*, 9:152-57.
- Huang, Y. J., H. Akbari, H. Taha, and A. H. Rosenfeld. 1987. "The Potential of Vegetation in Reducing Summer Cooling Loads in Residential Buildings." *Journal of Climate and Applied Meteorology* 26 (9): 1103-16.
- Irga, P.J., F.R. Torpy, and M.D. Burchett. 2013. "Can Hydroculture Be Used to Enhance the Performance of Indoor Plants for the Removal of Air Pollutants?" *Atmospheric Environment* 77 (October): 267-71.
- Jayasinghe, C., and M. T. R. Jayasinghe. 2009. *Sustainable Design of Built Environments*. Eco Ceylon (Pvt.) Limited.
- Jesionek, Kai, and Michael Bruse. 2003. "Impacts of Vegetation on the Microclimate: Modeling Standardized Building Structures with Different Greening Levels." *ICUC5, Lodz*.
- Jolliffe, P. A., and E. B. Tregunna. 1968. "Effect of Temperature, CO<sub>2</sub> Concentration, and Light Intensity on Oxygen Inhibition of Photosynthesis in Wheat Leaves." *Plant Physiology* 43 (6): 902-6.

- Jones, Hamlyn G. 1992. *Plants and Microclimate: A Quantitative Approach to Environmental Plant Physiology*. Second edition. Cambridge University Press.
- Jonsson, Per. 2004. "Vegetation as an Urban Climate Control in the Subtropical City of Gaborone, Botswana." *International Journal of Climatology* 24 (10): 1307-22.
- Kamaruzzaman, Syahrul Nizam, C.O. Egbu, Emma Marinie Ahmad Zawawi, Azlan Shah Ali, and Adi Irfan Che-Ani. 2011. "The Effect of Indoor Environmental Quality on Occupants' Perception of Performance: A Case Study of Refurbished Historic Buildings in Malaysia." *Energy and Buildings* 43 (2-3): 407-13.
- Lalic, Branislava, and Dragutin T. Mihailovic. 2004. "An Empirical Relation Describing Leaf-Area Density inside the Forest for Environmental Modeling." *Journal of Applied Meteorology* 43 (4): 641-45.
- Law, B. E., S. Van Tuyl, A. Cescatti, and D. D. Baldocchi. 2001. "Estimation of Leaf Area Index in Open-Canopy Ponderosa Pine Forests at Different Successional Stages and Management Regimes in Oregon." *Agricultural and Forest Meteorology* 108 (1): 1-14.
- Leyten, Joe L., and Stanley R. Kurvers. 2006. "Robustness of Buildings and HVAC Systems as a Hypothetical Construct Explaining Differences in Building Related Health and Comfort Symptoms and Complaint Rates." *Energy and Buildings* 38 (6): 701-7.
- Li, Jian-feng, Onyx W.H. Wai, Y.S. Li, Jie-min Zhan, Y. Alexander Ho, James Li, and Eddie Lam. 2010. "Effect of Green Roof on Ambient CO<sub>2</sub> Concentration." *Building and Environment* 45 (12): 2644-51.
- Li, Jian-Feng, Jie-Min Zhan, Y.S. Li, and Onyx W.H. Wai. 2013. "CO<sub>2</sub> Absorption/emission and Aerodynamic Effects of Trees on the Concentrations in a Street Canyon in Guangzhou, China." *Environmental Pollution* 177 (June): 4-12.
- Liu, Yan-Ju, Yu-Jing Mu, Yong-Guan Zhu, Hui Ding, and Nan Crystal Arens. 2007. "Which Ornamental Plant Species Effectively Remove Benzene from Indoor Air?" *Atmospheric Environment* 41 (3): 650-54.

- Lü, Xiaoshu, Tao Lu, Martti Viljanen, and Charles J. Kibert. 2013. "A New Method for Controlling CO<sub>2</sub> in Buildings with Unscheduled Opening Hours." *Energy and Buildings* 59 (April): 161-70.
- Meir, Patrick, John Grace, and Antonio C. Miranda. 2000. "Photographic Method to Measure the Vertical Distribution of Leaf Area Density in Forests." *Agricultural and Forest Meteorology* 102: 105-11.
- Milton, Donald K., P. Mark Glencross, and Michael D. Walters. 2000. "Risk of Sick Leave Associated with Outdoor Air Supply Rate, Humidification, and Occupant Complaints." *Indoor Air* 10 (4): 212-21.
- Mochida, A, S Murakami, T Ojima, S Kim, R Ooka, and H Sugiyama. 1997. "CFD Analysis of Mesoscale Climate in the Greater Tokyo Area." *Journal of Wind Engineering and Industrial Aerodynamics* 67 & 68: 459-77.
- Moonen, Peter, Thijs Defraeye, Viktor Dorer, Bert Blocken, and Jan Carmeliet. 2012. "Urban Physics: Effect of the Micro-Climate on Comfort, Health and Energy Demand." *Frontiers of Architectural Research* 1 (3): 197-228.
- Mysen, Mads, Sveinung Berntsen, Per Nafstad, and Peter G. Schild. 2005. "Occupancy Density and Benefits of Demand-Controlled Ventilation in Norwegian Primary Schools." *Energy and Buildings* 37 (12): 1234-40.
- Nassif, Nabil. 2012. "A Robust CO<sub>2</sub>-Based Demand-Controlled Ventilation Control Strategy for Multi-Zone HVAC Systems." *Energy and Buildings* 45 (February): 72-81.
- Neumann, H. H., G. Den Hartog, and R. H. Shaw. 1989. "Leaf Area Measurements Based on Hemispheric Photographs and Leaf-Litter Collection in a Deciduous Forest during Autumn Leaf-Fall." *Agricultural and Forest Meteorology* 45 (3-4): 325-45.
- Ng, Edward, Liang Chen, Yingna Wang, and Chao Yuan. 2012. "A Study on the Cooling Effects of Greening in a High-Density City: An Experience from Hong Kong." *Building and Environment*, International Workshop on Ventilation, Comfort, and Health in Transport Vehicles, 47 (January): 256-71.



- Norhidayah, A., Lee Chia-Kuang, M.K. Azhar, and S. Nurulwahida. 2013. "Indoor Air Quality and Sick Building Syndrome in Three Selected Buildings." *Procedia Engineering* 53: 93-98.
- Oh, Geun Sug, Gun Joo Jung, Min Ho Seo, and Young Bin Im. 2011. "Experimental Study on Variations of CO<sub>2</sub> Concentration in the Presence of Indoor Plants and Respiration of Experimental Animals." *Horticulture, Environment, and Biotechnology* 52 (3): 321-29.
- Owen, Susan Margaret, Christophe Boissard, and C. Nicholas Hewitt. 2001. "Volatile Organic Compounds (VOCs) Emitted from 40 Mediterranean Plant Species:: VOC Speciation and Extrapolation to Habitat Scale." *Atmospheric Environment* 35 (32): 5393-5409.
- Pegas, P. N., C. A. Alves, T. Nunes, E. F. Bate-Epey, M. Evtuygina, and C. A. Pio. 2012. "Could Houseplants Improve Indoor Air Quality in Schools?" *Journal of Toxicology and Environmental Health. Part A* 75 (22-23): 1371-80.
- Pepper, Darrell W., and David Carrington. 2009. *Modeling Indoor Air Pollution*. London : Singapore ; Hackensack, NJ: Imperial College Press.
- Persily, Andrew. 1997. "Evaluating Building IAQ and Ventiltion with Indoor Carbon Dioxide." *ASHRAE Transactions* 2.
- Raza, S. H., and G. Shylaja. 1992. "Studies of Tolerance of Certain Succulent Plants to Ambient Air Sulfur Dioxide Levels in Urban Environments of a City in India — a New Approach." *International Journal of Environmental Studies* 42 (4): 301-18.
- Raza, S. H., G. Shylaja, and B. V. Gopal. 1995. "Different Abilities of Certain Succulent Plants in Removing CO<sub>2</sub> from the Indoor Environment of a Hospital." *Environment International* 21 (4): 465-69.
- Raza, S.H. 1995. "Plant Life Forms in Thermal Regulation and Self Purification of Urban Housing Environments." *Indoor and Built Environment* 4 (1): 58-61.
- Redlich, Carrie A, Judy Sparer, and Mark R Cullen. 1997. "Sick-Building Syndrome." *The Lancet* 349 (9057): 1013-16.
- Rijal, Hom Bahadur, Ryozo Ooka, Hong Huang, Takeaki Katsuki, and Byoungchull Oh. 2010. "Study on Heat Island Mitigation Effect of Large-Scale Greenery Using Numerical Simulation."

- Rios, José Luiz de Magalhães, José Laerte Boechat, Adriana Gioda, Celeste Yara dos Santos, Francisco Radler de Aquino Neto, and José Roberto Lapa e Silva. 2009. "Symptoms Prevalence among Office Workers of a Sealed versus a Non-Sealed Building: Associations to Indoor Air Quality." *Environment International* 35 (8): 1136-41.
- Rotton, J., and S. M. White. 1996. "Air Pollution, the Sick Building Syndrome, and Social Behavior." *Environment International* 22 (1): 53-60.
- Rubino, Federico Maria, Lucia Florida, Manuela Tavazzani, Silvia Fustinoni, Rosario Giampiccolo, and Antonio Colombi. 1998. "Height Profile of Some Air Quality Markers in the Urban Atmosphere Surrounding a 100 M Tower Building." *Atmospheric Environment* 32 (20): 3569-80.
- Saxena, Mudit. 2002. "Microclimate Modification: Calculating the Effect of Trees on Air Temperature." In *proceedings of the solar conference*, 591-96.
- Seiler, Wolfgang, and Jack Fishman. 1981. "The Distribution of Carbon Monoxide and Ozone in the Free Troposphere." *Journal of Geophysical Research: Oceans* 86 (C8): 7255-65.
- Sharlin, N., and M. E. Hoffman. 1984. "The Urban Complex as a Factor in the Air-Temperature Pattern in a Mediterranean Coastal Region." *Energy and Buildings* 7 (2): 149-58.
- Shashua-Bar, Limor, and Milo E Hoffman. 2002. "The Green CTTC Model for Predicting the Air Temperature in Small Urban Wooded Sites." *Building and Environment* 37 (12): 1279-88.
- Shashua-Bar, Limor, and Milo E. Hoffman. 2004. "Quantitative Evaluation of Passive Cooling of the UCL Microclimate in Hot Regions in Summer, Case Study: Urban Streets and Courtyards with Trees." *Building and Environment* 39 (9): 1087-99.
- Singh, Jajit. 1996. "Review: Health, Comfort and Productivity in the Indoor Environment." *Indoor and Built Environment* 5 (1): 22-33.
- Sirimanna, M. P. G. "Heat gain to building interiors through roof; a study based on selected configurations in Sri Lanka", MSc Thesis, Department of Mechanical Engineering, University of Moratuwa, 2011



- Spangenberg, Jörg, Paula Shinzato, Erik Johansson, and Denise Duarte. 2008. "Simulation of the Influence of Vegetation on Microclimate and Thermal Comfort in the City of São Paulo." *Revista SBAU, Piracicaba* 3 (2): 1–19.
- Stenberg, Berndt, Nils Eriksson, Jonas Höög, Jan Sundell, and Stig Wall. 1994. "The Sick Building Syndrome (SBS) in Office Workers. A Case-Referent Study of Personal, Psychosocial and Building-Related Risk Indicators." *International Journal of Epidemiology* 23 (6): 1190–97.
- Su, Ying-Ming, and Chia-Hui Lin. 2013. "CO2 Purify Effect on Improvement of Indoor Air Quality (IAQ) through Indoor Vertical Greening." In *Proceedings of the World Congress on Engineering*. Vol. 2.
- Sumida, Akihiro, Taro Nakai, Masahito Yamada, Kiyomi Ono, Shigeru Uemura, and Toshihiko Hara. 2009. "Ground-Based Estimation of Leaf Area Index and Vertical Distribution of Leaf Area Density in a *Betula Ermanii* Forest." *Silva Fennica* 43 (5): 799–816.
- Sun, Zhongwei, Shengwei Wang, and Zhenjun Ma. 2011. "In-Situ Implementation and Validation of a CO2-Based Adaptive Demand-Controlled Ventilation Strategy in a Multi-Zone Office Building." *Building and Environment* 46 (1): 124–33.
- Susca, T., S. R. Gaffin, and G. R. Dell'Osso. 2011. "Positive Effects of Vegetation: Urban Heat Island and Green Roofs." *Environmental Pollution*, Selected papers from the conference Urban Environmental Pollution: Overcoming Obstacles to Sustainability and Quality of Life (UEP2010), 20-23 June 2010, Boston, USA, 159 (8–9): 2119–26.
- Takigawa, Tomoko, Yasuaki Saijo, Kanehisa Morimoto, Kunio Nakayama, Eiji Shibata, Masatoshi Tanaka, Takesumi Yoshimura, Hisao Chikara, and Reiko Kishi. 2012. "A Longitudinal Study of Aldehydes and Volatile Organic Compounds Associated with Subjective Symptoms Related to Sick Building Syndrome in New Dwellings in Japan." *Science of The Total Environment* 417–418 (February): 61–67.
- Tarran, Jane, Fraser Torpy, and Margaret Burchett. 2007. "Use of Living Pot-Plants to Cleanse Indoor Air—research Review." In *Proceedings Of 6 Th Internat.*

- Conf. On Indoor Air Quality, Ventilation & Energy Conservation,- Sustainable Built Environment*, 249-56.
- Treuhart, Robert N. 2002. "Forest Leaf Area Density Profiles from the Quantitative Fusion of Radar and Hyperspectral Data." *Journal of Geophysical Research* 107 (D21).
- Vos, Peter E.J., Bino Maiheu, Jean Vankerkom, and Stijn Janssen. 2012. "Improving Local Air Quality in Cities: To Tree or Not to Tree?" *Environmental Pollution*.
- Weng, Qihao. 2001. "A Remote Sensing? GIS Evaluation of Urban Expansion and Its Impact on Surface Temperature in the Zhujiang Delta, China." *International Journal of Remote Sensing* 22 (10): 1999-2014.
- WHO. 2012. "WHO Guidelines for Indoor Air Quality: Selected Pollutants". World Health Organization.
- Wolverton, B. C., Annett Johnson, and Keith Bounds. 1989. *Interior Landscape Plant for IAP Abatement*. NASA.
- Wong, Nyuk Hien, Yu Chen, Chui Leng Ong, and Angelia Sia. 2003. "Investigation of Thermal Benefits of Rooftop Garden in the Tropical Environment." *Building and Environment* 38 (2): 261-70.
- Wong, Nyuk Hien, and Bernard Huang. 2004a. "Comparative Study of the Indoor Air Quality of Naturally Ventilated and Air-Conditioned Bedrooms of Residential Buildings in Singapore." *Building and Environment* 39 (9): 1115-23.
- Wong, Nyuk Hien, Alex Yong Kwang Tan, Yu Chen, Kannagi Sekar, Puay Yok Tan, Derek Chan, Kelly Chiang, and Ngian Chung Wong. 2010. "Thermal Evaluation of Vertical Greenery Systems for Building Walls." *Building and Environment* 45 (3): 663-72.
- Wong, Nyuk Hien, and Chen Yu. 2005. "Study of Green Areas and Urban Heat Island in a Tropical City." *Habitat International* 29 (3): 547-58.
- World Urbanization Prospects*. United Nations, Department of Economic and social affairs.
- Yang, Jun, Qian Yu, and Peng Gong. 2008. "Quantifying Air Pollution Removal by Green Roofs in Chicago." *Atmospheric Environment* 42 (31): 7266-73.

- Yang, Xiaoshan, Lihua Zhao, Michael Bruse, and Qinglin Meng. 2013. "Evaluation of a Microclimate Model for Predicting the Thermal Behavior of Different Ground Surfaces." *Building and Environment* 60 (February): 93-104.
- Yarn, Kao-Feng, Kuang-Cheng Yu, Jeng-Min Huang, Win-Jet Luo, and Pei-Cheng Wu. 2013. "Utilizing a Vertical Garden to Reduce Indoor Carbon Dioxide in an Indoor Environment." *Wulfenia Journal* 20 (October).
- Yu, Chen, and Wong Nyuk Hien. 2006. "Thermal Benefits of City Parks." *Energy and Buildings* 38 (2): 105-20.
- Yuan, Chao, and Edward Ng. 2012. "Building Porosity for Better Urban Ventilation in High-Density Cities – A Computational Parametric Study." *Building and Environment* 50 (April): 176-89.
- Zhao, Juan, and Xudong Yang. 2003. "Photocatalytic Oxidation for Indoor Air Purification: A Literature Review." *Building and Environment* 38 (5): 645-54.

ANNEX A

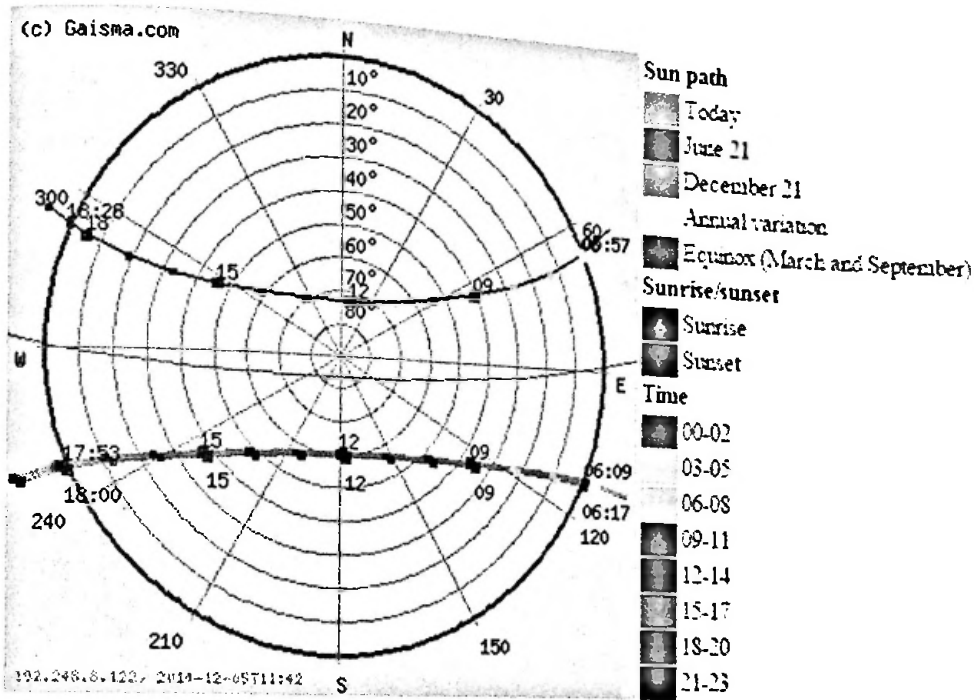

Figure A: Sun path for Sri Lanka

## ANNEX B

The Equation 4-3 for CO<sub>2</sub> balance in a controlled volume mechanically ventilated room is,

$$v \frac{dc}{dt} = Q[C_0 - C(t)] + G$$

$$\frac{dc}{dt} + \frac{Q}{v}C(t) = \frac{QC_0 + G}{v}$$

$$\frac{dc}{dt} + IC(t) - \frac{QC_0 + G}{v} = 0$$

Integrating factor =  $e^{\int I dt} = e^{It}$

$$e^{It} \cdot \frac{dc}{dt} + e^{It} \cdot IC(t) = e^{It} \cdot \frac{QC_0 + G}{v}$$

$$\frac{d(e^{It} \cdot C)}{dt} = \frac{QC_0 + G}{v} \cdot e^{It}$$

$$e^{It} \cdot C = \left( \frac{QC_0 + G}{v} \right) \cdot \frac{e^{It}}{I} + k$$

$$C(t) = \left( C_0 + \frac{G}{Q} \right) + e^{-It}k ; I = \frac{Q}{v}$$

When  $t = 0$ ;

$$C(0) = \left( C_0 + \frac{G}{Q} \right) + e^0k$$

$$k = C(0) - \left( C_0 + \frac{G}{Q} \right)$$

$$C(t) = C_0 + \frac{G}{Q} + \left\{ C(0) - C_0 - \frac{G}{Q} \right\} e^{-It}$$

The solution for Equation 4-6 which models the mechanically ventilated room with occupants and plants when the absorption rate is constant with the increase of CO<sub>2</sub> concentration is as follows.

$$v \frac{dc}{dt} = Q[C_0 - C(t)] + G - \alpha S$$

$$\frac{dc}{dt} + \frac{Q}{v} C(t) = \frac{QC_0 + (G - \alpha S)}{v}$$

$$\frac{dc}{dt} + IC(t) - \frac{QC_0 + (G - \alpha S)}{v} = 0$$

Integrating factor =  $e^{\int I dt} = e^{It}$

$$e^{It} \cdot \frac{dc}{dt} + e^{It} \cdot IC(t) = e^{It} \cdot \frac{QC_0 + (G - \alpha S)}{v}$$

$$\frac{d(e^{It} \cdot C)}{dt} = \frac{QC_0 + (G - \alpha S)}{v} \cdot e^{It}$$

$$e^{It} \cdot C = \left( \frac{QC_0 + (G - \alpha S)}{v} \right) \cdot \frac{e^{It}}{I} + k$$

$$C(t) = \left( C_0 + \frac{(G - \alpha S)}{Q} \right) + e^{-It} k ; I = \frac{Q}{v}$$

When  $t = 0$ ;

$$C(0) = \left( C_0 + \frac{(G - \alpha S)}{Q} \right) + e^0 k$$

$$k = C(0) - \left( C_0 + \frac{(G - \alpha S)}{Q} \right)$$

$$C(t) = C_0 + \frac{(G - \alpha S)}{Q} + \left\{ C(0) - C_0 - \frac{(G - \alpha S)}{Q} \right\} e^{-It}$$

The solution for Equation 4-7 which models the mechanically ventilated room with occupants and plants when the absorption rate is linearly increasing with the increase of CO<sub>2</sub> concentration is as follows.

$$v \frac{dc}{dt} = Q[C_0 - C(t)] + G - \gamma S C(t)$$

$$\frac{dc}{dt} + \frac{Q + \gamma S}{v} C(t) = \frac{QC_0 + G}{v}$$

$$\frac{dc}{dt} + \left(1 + \frac{\gamma S}{v}\right) \cdot C(t) - \frac{QC_0 + G}{v} = 0$$

Integrating factor =  $e^{\int (1 + \frac{\gamma S}{v}) dt} = e^{(1 + \frac{\gamma S}{v})t}$

$$e^{(1 + \frac{\gamma S}{v})t} \cdot \frac{dc}{dt} + e^{(1 + \frac{\gamma S}{v})t} \cdot \left(1 + \frac{\gamma S}{v}\right) C(t) = e^{(1 + \frac{\gamma S}{v})t} \cdot \frac{QC_0 + G}{v}$$

$$\frac{d(e^{(1 + \frac{\gamma S}{v})t} \cdot C)}{dt} = \frac{QC_0 + G}{v} \cdot e^{(1 + \frac{\gamma S}{v})t}$$

$$e^{(1 + \frac{\gamma S}{v})t} \cdot C = \left(\frac{QC_0 + G}{v}\right) \cdot \frac{e^{(1 + \frac{\gamma S}{v})t}}{\left(1 + \frac{\gamma S}{v}\right)} + k$$

$$C(t) = \left(\frac{QC_0 + G}{Q + \gamma S}\right) \cdot e^{-(1 + \frac{\gamma S}{v})t} + k ; I = \frac{Q}{v}$$

When  $t = 0$ ;

$$C(0) = \left(\frac{QC_0 + G}{Q + \gamma S}\right) + e^0 k$$

$$k = C(0) - \left(\frac{QC_0 + G}{Q + \gamma S}\right)$$

$$C(t) = \frac{QC_0 + G}{Q + \gamma S} + \left\{C(0) - \frac{QC_0 + G}{Q + \gamma S}\right\} e^{-(1 + \frac{\gamma S}{v})t}$$



## ANNEX C

An attempt has been made to have vegetation in the model to represent the local plants. Initially crown profile from one cross section was obtained as shown in Figure C.1. The total height was equally divided to 10 bands. The area of the profile was then determined for each division. The fraction of maximum area for each division was then determined. The maximum leaf are density was multiplied this fraction and the leaf area density profile was obtained.

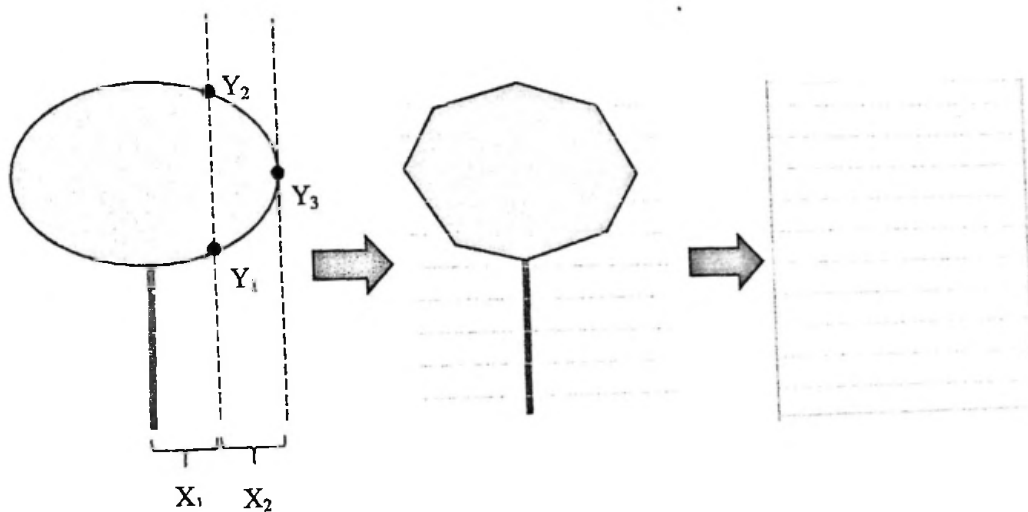

Figure C.1: Determination of the crown profile

The maximum leaf area densities were obtained using literature. A tree of a same structure as the local plants were found in literature. The trees were defined to have circular cross section horizontally.

# ANNEX D

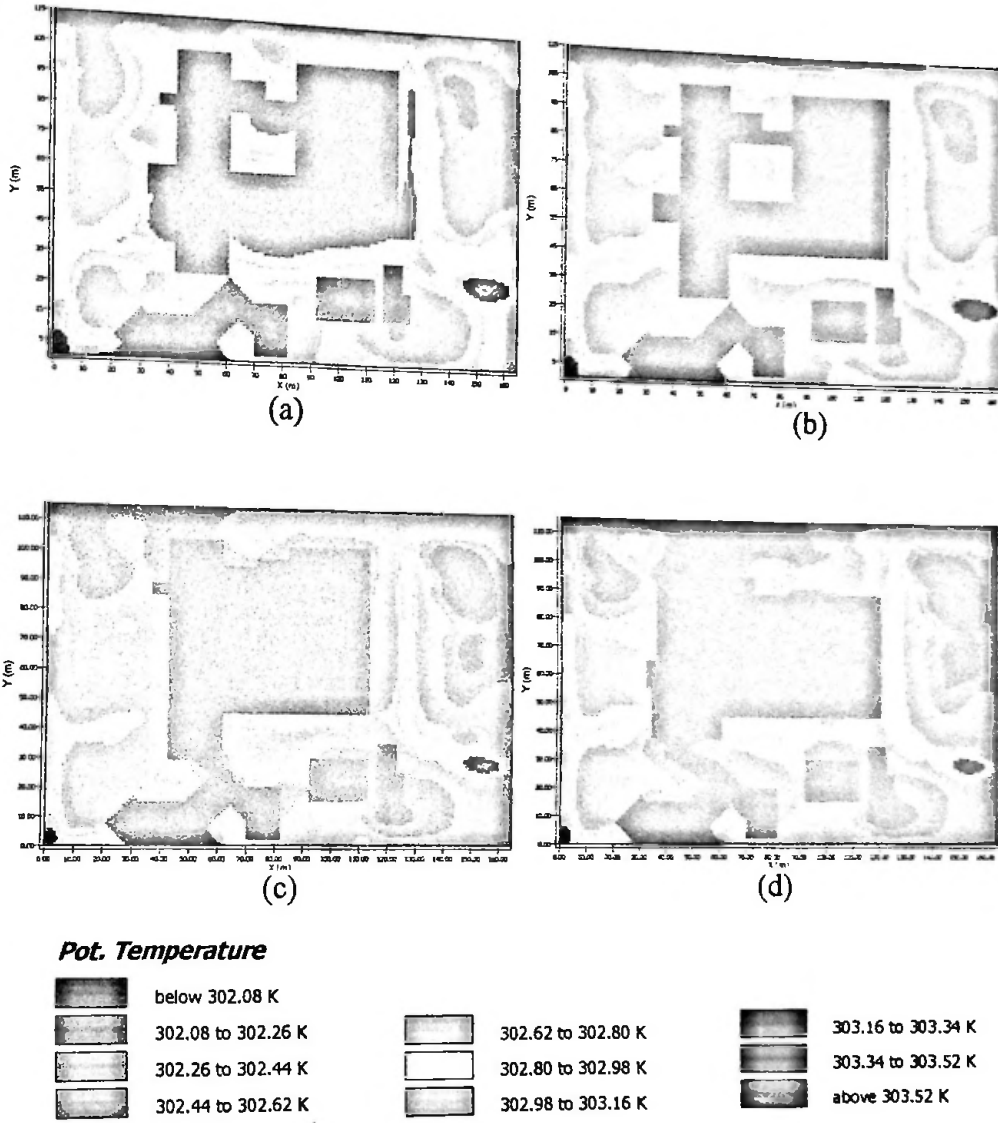

Figure Error! No text of specified style in document.:1: Atmospheric temperature at 1m height in defined cases (a-Combination 2, b- Combination 3, c- Combination 9, d- Combination 10)

# ANNEX E

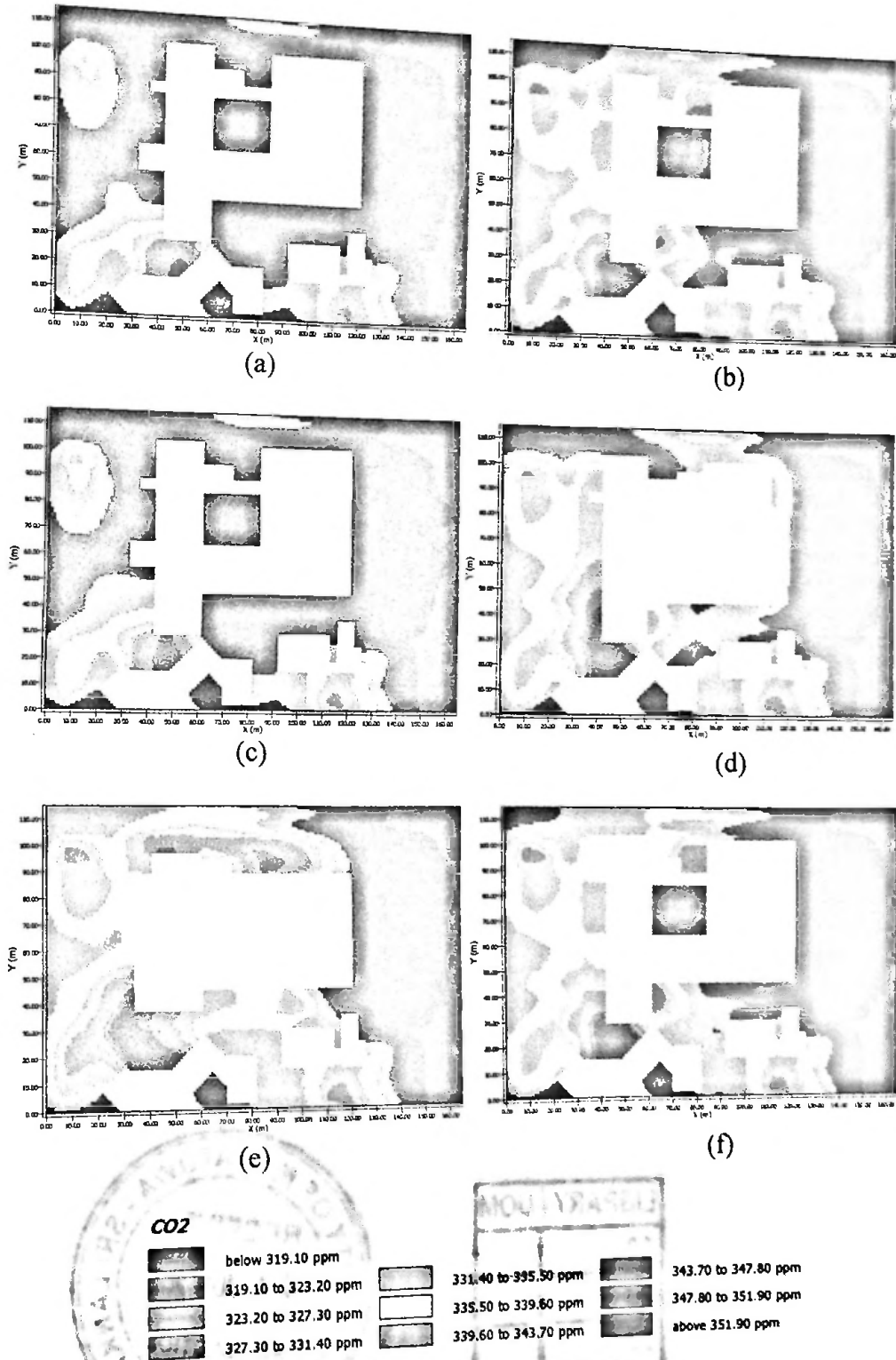

Figure E.1: Atmospheric CO<sub>2</sub> concentration at 1m height at 1.00 pm in defined cases (a- Combination 2, b- Combination 3, c- Combination 4, d- Combination 5a, e- Combination 5b, f- Combination 6)